



Section 00 01 01
PROJECT MANUAL & TITLE PAGE

**INCLUDING
CONTRACT DOCUMENTS
AND
SPECIFICATIONS**

FOR THE

**PUBLIC IMPROVEMENT
DESCRIBED AS:**

**Riverview Community Center
Flooring Replacement**

Project Number RV-1-2021

401 Willow Drive
Bakersfield, California



Division 00 00 00
Procurement and Contracting
Requirements

SECTION 00 01 10 TABLE OF CONTENTS

BID DOCUMENTS

00 00 00 – PROCUREMENT AND CONTRACTING REQUIREMENTS

<u>Section</u>	<u>Title</u>	<u>Page</u>
00 01 01	Title Page	00 01 01: 1
00 01 10	Table of Contents	00 01 10: 1-4
00 01 20	List of Drawing Sheets	00 01 20: 1
00 11 13	Advertisement for Bids	00 11 13: 1
00 16 11	Invitation to Bidders	00 16 11: 1-2
00 21 13	Instructions to Bidders	00 21 13: 1-8
00 25 13	Pre-Bid Meetings	00 25 13: 1
00 27 00	Bid Protest Procedure	00 27 00: 1-2
00 31 11	Project Summary	00 31 11: 1
00 41 00	Bid Form	00 41 00: 1-4
00 43 13	Bid Security Form	00 43 13: 1-2
00 43 36	Proposed Subcontractors Form	00 43 36: 1
00 43 93	Bid Submittal Checklist	00 43 93: 1
00 45 13	Bidder's Qualifications	00 45 13: 1
00 45 19	Non-Collusion Affidavit	00 45 19: 1
00 45 26	Workers' Compensation Certification	00 45 26-1
00 45 33	Non-Segregated Facilities Certification	00 45 33: 1
00 45 36	Equal Employment Opportunity and Prevailing Wage/ Compliance Certification	00 45 36: 1
00 45 37	Certification of Performance on Previous Equal Employment Opportunity Contracts	00 45 37: 1
00 52 00	Agreement for Construction	00 52 00: 1-3
00 61 13.13	Faithful Performance Bond	00 61 13.13: 1-2
00 61 13.16	Payment Bond	00 61 13.16: 1-2
00 62 24	Certificate of Exclusion of Asbestos and Lead Products	00 62 24: 1
00 63 13	Request for Information Form	00 63 13: 1
00 65 36	Warranty Form	00 65 36: 1
00 72 00	General Conditions of the Contract	00 72 00:1-32
00 73 00	Supplementary Conditions of the Contract	00 73 00: 1-4
00 91 13	Addenda	00 91 13: 1

TECHNICAL SPECIFICATIONS

DIVISION 1 – GENERAL REQUIREMENTS

01 11 00	Summary of Work	01 11 00: 1-3
01 23 00	Alternates	01 23 00: 1
01 25 00	Submittal and Substitution Procedures	01 25 00: 1-3
01 31 19	Project Meetings	01 31 19: 1-2
01 32 33	Photographic Documentation	01 32 33: 1
01 45 00	Testing Laboratory Services	01 45 00: 1-2

01 50 00	Temporary Facilities and Controls	01 50 00: 1-3
01 71 23	Field Engineering	01 71 23: 1-2
01 73 29	Cutting and Patching	01 73 29: 1-2
01 74 00	Cleaning & Waste Management	01 74 00: 1-3
01 78 00	Closeout Submittals	01 78 00: 1-2
01 78 23	Operation & Maintenance Data	01 78 23: 1-3
01 78 39	Project Record Documents	01 78 39: 1-4

DIVISION 2 –
EXISTING
CONDITIONS

DIVISION 3 –
CONCRETE

DIVISION 4 –
MASONRY

DIVISION 5 –
METALS

DIVISION 6 –
WOOD, PLASTICS
AND
COMPOSITES

DIVISION 7 –
THERMAL AND
MOISTURE
PROTECTION

DIVISION 8 –
OPENINGS

DIVISION 9 – FINISHES

09 65 19.23	Vinyl Tile Flooring	09 65 19.23: 1-15
-------------	---------------------	-------------------

DIVISION 10 –
SPECIALTIES

DIVISION 11 –
EQUIPMENT

DIVISION 12 –
FURNISHINGS

DIVISION 13 – SPECIAL CONSTRUCTION

DIVISION 14 – CONVEYING EQUIPMENT

DIVISION 15 – NOT USED

DIVISION 16 – NOT USED

DIVISION 17 – NOT USED

DIVISION 18 – NOT USED

DIVISION 19 – NOT USED

DIVISION 20 – NOT USED

DIVISION 21 – FIRE SUPPRESSION

DIVISION 22 – PLUMBING

DIVISION 23 – HEATING, VENTING AND AIR CONDITIONING (HVAC)

DIVISION 24 – NOT USED

DIVISION 25 – INTEGRATED AUTOMATION

DIVISION 26 – ELECTRICAL

DIVISION 27 – COMMUNICATION

DIVISION 28 – ELECTRONIC SAFETY AND SECURITY

DIVISION 29 – NOT USED

DIVISION 30 – NOT USED

DIVISION 31 – EARTHWORK

DIVISION 32 – EXTERIOR IMPROVEMENTS

DIVISION 33 – UTILITIES

DIVISION 34 – TRANSPORTATION

DIVISION 35 – WATERWAY AND MARINE CONSTRUCTION

DIVISION 36 – NOT USED

DIVISION 37 – NOT USED

DIVISION 38 – NOT USED

DIVISION 39 – NOT USED

DIVISION 40 –PROCESS INTERCONNECTIONS

DIVISION 41 – MATERIAL PROCESSING AND HANDLING EQUIPMENT

DIVISION 42 – PROCESS HEATING, COOLING AND DRYING EQUIPMENT

DIVISION 43 – PROCESS GAS AND LIQUID HANDLING, PURIFICATION AND STORAGE EQUIPMENT

DIVISION 44 – POLLUTION AND WASTE CONTROL EQUIPMENT

DIVISION 45 – INDUSTRY-SPECIFIC MANUFACTURING EQUIPMENT

DIVISION 46 – WATER AND WASTEWATER EQUIPMENT

DIVISION 47 – NOT USED

DIVISION 48 – ELECTRICAL POWER GENERATION

**SECTION 00 01 15
LIST OF DRAWING SHEETS**

See Floor Plan, this section, for Limit of Work at Riverview Community Center.

END OF SECTION

SECTION 00 11 13 ADVERTISEMENT FOR BIDS

NOTICE IS HEREBY GIVEN that NORTH OF THE RIVER RECREATION AND PARK DISTRICT, hereinafter referred to as "NOR," will receive sealed bids at NOR'S Administrative Complex, 3825 Riverlakes Drive, Bakersfield, Kern County, California, until 2:00pm PST, **Monday, July 13, 2020** for the public improvements consisting, in general, of the following: **Riverview Community Center Flooring Replacement, #RV-1-2021.**

This Project requires a California C-15 Flooring and Floor Covering Contractor's License.

A mandatory pre-bid meeting is scheduled at 9:00am, **Wednesday, July 1, 2020** at Riverview Community Center, 401 Willow Drive, Bakersfield, California.

Bidders are notified of requirements by California Department of Industrial Relations for the registration of contractors and subcontractors; project compliance monitoring and enforcement by the Department of Industrial Relations; posting of job site notices prescribed by regulation; as well as compliance with all prevailing wage and apprenticeship standards pursuant to California Labor Code part 7, chapter 1, article 2, sections 1725.5, 1771.1, 1771.4, and 1777.5, et. al.

Bidders are further notified that all of the above described public work shall be performed pursuant to and in accordance with Contract Documents provided by NOR. Said Contract Documents are available on NOR's website at <http://www.norfun.org>. NOR is not authorized to give oral explanations or interpretations of Contract Documents, and a submission of a Proposal constitutes agreement that the Bidder has placed no reliance on any such oral explanation or interpretation. However, NOR may, upon inquiry by Bidder, orally direct the Bidder's attention to the specific provision of the Contract Documents that cover the subject of the inquiry.

Bidders are further notified that each bid must be made on the proposal form furnished by NOR; bids must be received on or before the date and hour above specified or such bid will be rejected; all bids timely received by NOR will be opened and publicly read at the above address and time.

Each bid shall be accompanied by a certified check or bidder's bond in the amount of ten (10) percent of the maximum total bid. In addition, the successful bidder shall be required to furnish a Faithful Performance Bond and a Labor and Materials Bond in the amounts set forth in the Specifications and General Conditions. In accordance with the provisions of Government Code Section 4590, securities may be submitted for any monies which NOR may withhold pursuant to the terms of the contract to insure performance.

Bidders are further notified it shall be mandatory upon the Contractor to whom a contract is awarded, and upon all subcontractors under him, to pay not less than the general prevailing rates of per diem wages to all workmen in the execution of the contract. Pursuant to the provisions of the California State Labor Code, and Local Laws thereto applicable, the said Board of Directors has ascertained the prevailing rate of wages in the locality where this work is to be performed, for each craft and/or type of workman or mechanic needed to perform the work of this contract. General Prevailing Wage Rates shall be those rates pertaining to Kern County as published by the Director of Industrial Relations pursuant to California Labor Code, Part 7, Chapter 1, Article 2, Sections 1770, 1773, 1773.1, and 1777.5. The minimum wage rates applicable for each craft, classification or type of worker needed for the aforesaid public work is set forth in a prevailing wage schedule available at California Department of Industrial Relations (www.dir.ca.gov/dlsr/pwd/index.htm) website.

Copies of the Prevailing Wage Schedules may be obtained from the Division of Labor Research and Statistics, P.O. Box 420603, San Francisco, CA. 94142, (415) 703-4774.

NOR's Board of Directors reserves the right to accept or reject any and all bids and to waive any informality or irregularity in any bid.

Dated: 6.27.2020

/s/ Racheal Garcia

CLERK OF THE BOARD OF DIRECTORS OF NORTH
OF THE RIVER RECREATION AND PARK DISTRICT



TO: Potential Bidder

FROM: Bid Administrator
North of the River Recreation & Park District
3825 Riverlakes Drive
Bakersfield, CA 93312
bids@norrecreation.org
(661) 392.2000

DATE: June 25, 2020

SUBJECT: Request for Bids – Riverview Community Center Flooring Replacement, #RV-1-2021

North of the River Recreation and Park District (NOR) is seeking bids for the flooring replacement at Riverview Community Center. The work shall be completed August 2020.

A **MANDATORY** pre-bid conference will be held on-site on Wednesday, July 1, 2020 at 9:00am PST. Site address is 401 Willow Drive, Bakersfield, California. Interested bidders may set up an individual site visit if needed, but this does not exempt one from the pre-bid walk. All questions and RFIs shall be directed to Bid Administrator at bids@norrecreation.org.

Items specified and directed in attached specifications are used to describe the quality and craftsmanship required and do not detail the exact work to be completed. Contractor shall be experienced with removal of existing flooring, installation, and other necessary work and shall submit a current licensed contractor certificate, liability insurance form to \$2 Million in coverage and workman's compensation forms and additional certifications as required by the District with the bid form. Bids submitted without the above forms will not be considered. **BIDS ARE DUE BY MONDAY, JULY 13, 2020 at 2:00 PM PST.** Bids may be mailed, emailed or hand delivered. Bids sent by mail, email or hand delivered shall be sealed and labeled on the envelope: Project #RV-1-2021. Emailed bids shall be sent as an email attachment in portable document format (PDF) referencing Project #RV-1-2021 to bids@norrecreation.org. All bids must be submitted on the enclosed form with all required documentation listed in specifications. Bidder must provide lead time in space provided on the bid form.

NOR respectfully requests that all bids be submitted via mail or email. Staff is limited at the office to accept hard copy bids due to COVID-19 California Executive orders. If a hard copy bid is to be submitted, please contact the Bid Administrator to make arrangements at least two (2) hours before bid opening. Bid opening will be held via remote video conferencing. A link shall be posted to the NOR website one (1) hour before the posted bid opening time.

Contractor shall thoroughly read all attached documents and agree to comply with all notices and documents as contained in this bid package. By submitting a bid, Contractor is agreeing to all terms.

If potential purchase orders are to be made to a company not listed as the bidding firm, please provide their information in the designated area on the bid request form.

Bidders are notified of requirements by California Department of Industrial Relations for the registration of contractors and subcontractors; project compliance monitoring and enforcement by the Department of Industrial Relations; posting of job site notices prescribed by regulation; as well as compliance with all prevailing wage and apprenticeship standards pursuant to California Labor Code part 7, chapter 1, article 2, sections 1725.5, 1771.1, 1771.4, and 1777.5, et. al.

INDEX

SECTION 00 21 13 INSTRUCTIONS TO BIDDERS

- 1.01 Introduction
- 1.02 Definition of Terms
- 1.03 Examination of Site, Drawings, etc.
- 1.04 Addenda and Explanation to Bidders
- 1.05 Qualifications of Contractors
- 1.06 Designation of Subcontractors
- 1.07 Contract Bonds
- 1.08 Proposal Form and Preparation
- 1.09 Prices
- 1.10 Proposal Guarantee – Bidder’s Bonds
- 1.11 Address and Marking of Proposals
- 1.12 Withdrawals of Proposals
- 1.13 Lowest Responsible Bidder, Acceptance or Rejection of Proposals
- 1.14 Award and Execution of Contract
- 1.15 Return of Proposal Guarantee

SECTION 00 21 13 INSTRUCTIONS TO BIDDERS

1.01 Introduction

- a. Each proposal shall be in accordance with the Contract Documents prepared by NOR.

1.02 Definition of Terms

- a. Whenever used in any of the Contract Documents, the following terms shall have the meanings hereinafter set forth.

- (1) The words "Contract Documents" shall mean any or all of the following items as applicable:

Notice to Contractors
Instructions to Bidders
The Proposal
Proposal Guarantee (Bidder's Bond)
Bidder's Statement of Experience Qualifications
Bidder's Designation of Subcontractors
Contract Agreement
Noncollusion Affidavit
Guaranty
Certificate of Exclusion of Asbestos and Lead Products
Certification Regarding Playground Equipment Installation
Faithful Performance Bond
Payment Bond
Certificate(s) of Insurance
Certificates of Compliance
General Conditions of the Contract
Supplementary Conditions of the Contract
Specifications
Drawings
Addenda (if applicable)
Contract Change Orders (if applicable)

Each of these items is to be considered by reference as part of the Contract Agreement.

- (2) Contract: The Contract is the written agreement covering the performance of the work and the furnishing of labor, materials, tools and equipment in connection with the work. It includes supplemental agreements amending or extending the work contemplated and which may be required to complete the work in a substantial and acceptable manner. Supplemental agreements are written agreements covering alterations, amendments, or extensions to the Contract and include Contract Change Orders.
- (3) NOR: NOR is North of the River Recreation and Park District of Kern County, California. NOR is the Owner whenever Owner is used in specifications or on plans.
- (4) Acceptance: The formal written acceptance of the work by NOR or its authorized representative.
- (5) Board of Directors or Board: The Board of Directors, or Board, is the Board of Directors of North of the River Recreation and Park District.

- (6) Engineer: The term "Engineer" refers to NOR's designated technical representatives assigned administrative responsibilities during the course of construction to make appropriate inspections, testing or interpretation of work. If no such individual has been designated, "Engineer" shall refer to "NOR" and/or "Owner".
- (7) Surveyor: The term "Surveyor" refers to NOR staff or NOR's properly authorized agents, or when required, a surveyor hired by the Contractor which performs designated survey work.
- (8) Contractor: The term "Contractor" used herein or in other sections of the Contract Documents means the person, firm or corporation with whom the Contract Agreement is made by NOR for the performance of work herein described.
- (9) Subcontractor: Any person, firm, or corporation other than an employee of the Contractor, supplying, for and under agreement with either the Contractor or any subcontractor of the Contractor, labor or materials or both, on or off the site of the Project in connection with this Contract.
- (10) Bidder: Any individual, firm, partnership, or corporation submitting a Proposal for the work contemplated acting directly or through a duly authorized representative.
- (11) Proposal: The offer of a Bidder for the work under any schedule or combination of schedules properly completed and submitted on the prescribed Proposal form, with appropriate signatures and Proposal Guarantee.
- (12) Proposal Guarantee: The cash, cashier's check, certified check, or Bidder's Bond accompanying the Proposal submitted by the Bidder, as a guarantee that the Bidder will enter into a contract with NOR for the performance of the work when the Contract is awarded to said Bidder.
- (13) Date of Execution of the Contract: The date on which the Contract is signed by NOR's authorized representative.
- (14) Days: Unless otherwise specifically stated, the term "days" will be understood to mean calendar days.
- (15) Work: The term "Work" shall mean all the work specified under schedules indicated, shown or contemplated in the Contract Documents, including all alterations, amendments or extensions thereto made by Contract change orders or other written orders of NOR or its Engineer.
- (16) Specifications: The term "Specifications" refers to terms, provisions and requirements contained herein and referred to as Specifications. Where Standard Specifications, such as those of "ASTM", "AASHTO", etc., have been referred to, the applicable portions of such Standard Specifications shall become a part of these Contract Documents.
- (17) Drawings: The term "Drawings" refers to the official plans, profiles, cross sections, evaluations, details, other working drawings and supplementary drawings, or reproductions which show the location, character, dimensions, and details of the work to be performed. Drawings may be either bound in the same book as in the balance of the Contract Documents or bound in separate sets, and are a part of the Contract Documents regardless of the method of binding.
- (18) Whenever in the Specifications or upon the Drawings, the words DIRECTED, REQUIRED, PERMITTED, ORDERED, DESIGNATED, PRESCRIBED, or words of like import are used, it shall be understood that the direction, requirement, permission, order, designation or prescription shall be according to NOR's intent and similarly the words APPROVED, ACCEPTABLE, SATISFACTORY, or words of like import, shall mean approved or acceptable to or satisfactory to NOR, unless otherwise expressly stated.

- (19) AASHO: The American Association of State Highway Officials.
- (20) ACI: The American Concrete Institute.
- (21) ADA: The Americans with Disabilities Act of 1990.
- (22) AISC: The American Institute of Steel Construction.
- (23) ISI: The American Iron and Steel Institute.
- (24) ASABE: American Society of Agricultural and Biological Engineers.
- (25) ASME: The American Society for Mechanical Engineers.
- (26) ASTM: The American Society for Testing Materials.
- (27) AWS: The American Welding Society.
- (28) AWWA: The American Water Works Association.
- (29) CCP: Code of Civil Procedure
- (30) IEEE: The Institute of Electrical and Electronics Engineers.
- (31) IPCEA: The Insulated Power Cable Engineers Association.
- (32) NEMA: The National Electrical Manufacturers Association.
- (33) SSPC: The Steel Structures Painting Council.
- (34) USAS: The United States of America Standard Institute.
- (35) County: County of Kern, California.
- (36) City: City of Bakersfield.
- (37) Elevation: The figures given in the Specifications or upon the Drawings after the word ELEVATION or an abbreviation of it, shall mean distances and feet above U.S. Coast and Geodetic Survey sea level data or a referenced fixed point. Actual elevation or relative elevations shall then be established by the Surveyor.
- (38) "Or Equal": Where the phrase "or equal" or "or equal as approved by NOR" occurs in the Contract Documents, do not assume that the materials, equipment, or methods will be approved as equal unless the item has been specifically so approved for this work by NOR.

1.03 Examination of Site, Drawings, etc.

- a. Each Bidder shall visit the site of the proposed Work and become fully acquainted with local conditions, construction and labor to insure a full understanding of the facilities, difficulties, and restrictions attending the execution of the work under the Contract. Bidders shall thoroughly examine and be familiar with the Drawings and Specifications. The failure of any Bidder to receive or examine any form, instrument, addendum, or other documents, or to visit the site and become acquainted with existing conditions shall in no way relieve the Bidder from any obligation with respect to a proposal or to the Contract. The Drawings for the Work show conditions as they are supposed or believed to exist; but it is neither intended nor to be inferred that the conditions as

shown thereon constitute a representation by NOR, or its officers or representatives, that such conditions are actually existent, nor shall NOR, or any of its officers or representatives be liable for any loss sustained by the Contractor as a result of a variance between conditions as shown on the Drawings and the actual conditions revealed during the progress of the Work.

- b. The Bidder shall investigate to insure satisfaction as to the conditions to be encountered, as to the character, quality and quantities of work to be performed and materials to be furnished, and as to the requirements of these Drawings and Specifications, and the Contract.

1.04 Addenda and Explanation to Bidders

- a. Any explanation desired by the Bidders regarding the meaning or interpretation of any of the Contract Documents must be requested in writing, with sufficient allowance of time for receipt of reply before the time set for opening of Proposals. Any such explanations or interpretations will be made in the form of addenda to the Documents and will be furnished to all Bidders who shall include costs for all addenda with their proposals.
- b. NOR is not authorized to give oral explanations or interpretations of Contract Documents, and a submission of a Proposal constitutes agreement that the Bidder has placed no reliance on any such oral explanation or interpretation. However, NOR may, upon inquiry by Bidder, orally direct the Bidder's attention to the specific provision of the Contract Documents that cover the subject of the inquiry.

1.05 Qualifications of Contractors

- a. It is not the intent to restrict or limit the Bidders; however, because of the specialized nature of the work, each Bidder and sub-bidder shall understand the following:
 - (1) The General Contractor must currently be licensed with an appropriate license classification to perform the Work of this Contract; and submit with the Proposal names and locations of at least five (5) projects previously completed or in progress which are of the similar size and difficulty.
 - (2) Each Subcontractor must currently be licensed for their specific classification of work; and must provide evidence, if requested, that they have successfully performed similar work in the past.
 - (3) The Bidders and Sub-Bidders are cautioned against attempting to substitute for specified items that have not been previously approved, and items which may not meet all the requirements of design and quality.
 - (4) It should be understood that close tolerances and conformity to Plans, Specifications, codes and good workmanship will be strictly enforced. Improper, non-conforming, or non-specified work will be immediately rejected, whenever noted, and all such work will be removed and replaced at no additional cost to NOR.

1.06 Designation of Subcontractors

- a. Each Bidder shall set forth in his Proposal on the form provided the following information in accordance with the provisions of Chapter 4, Part 1 of Division 2, of the Public Contract Code.
 - (1) The name, address of the place of business, class of license, license number and portion of work to be performed of each Subcontractor who will perform work or labor or render service to the prime Contractor in or about the construction of the work or improvement, or a Subcontractor licensed by the State of California, who, under subcontract to the prime Contractor, specially fabricates and installs a portion of the work or improvement according

to detailed Drawings contained in the Plans and Specifications, in any amount in excess of one-half of one percent of the prime Contractor's total bid.

- (2) The portion of the Work which will be done by each such Contractor. Only one Subcontractor shall be listed for each such portion of the Work as defined in the bid.
- (3) If the Bidder fails to specify a Subcontractor for any portion of the Work to be performed under the Contract, the prime Contractor agrees to perform that portion of the Work exclusively.

1.07 Contract Bonds

- a. The successful Contractor will be required to furnish both a Performance Bond and Payment Bond. The Performance Bond shall be in the amount of 100% of the total contract amount. The Payment Bond shall be in the amount required by Section 3247 et seq. of the Civil Code of the State of California (50% of total contract amount).
- b. Said bonds shall be furnished on the forms enclosed following the Agreement and shall be satisfactory to NOR and shall be obtained from a responsible corporate surety (or sureties) acceptable to NOR, which is licensed by the State of California to act as surety upon bonds and undertakings and which maintains in this state at least one office for conducting business. The surety (or sureties) shall furnish reports as to its financial condition if requested by NOR. NOR will interpret the phrase "reports as to its financial condition" to mean the reports specified in CCP Section 995.660(a)(4). The premiums for said bonds shall be paid by the Contractor.
- c. If any surety becomes unacceptable to NOR or fails to furnish reports as to its financial condition as requested by NOR, the Contractor shall promptly furnish such additional security as may be required to protect the interests of NOR and of persons supplying labor or materials in the prosecution of the work contemplated by this Contract.
- d. In the event of any conflict between the terms of the Contract and the terms of the bonds, the terms of the Contract shall control and the bonds shall be deemed to be amended thereby.
- e. Without limiting the foregoing, NOR shall be entitled to exercise all rights granted to it by the Contract in the event of the default without control thereof by the surety, provided that NOR gives the surety notice of such default at the time or before the exercise of any such right by NOR, and regardless of the terms of said bonds, the exercise of any such right by NOR shall in no manner affect the liability of the surety under said bonds.
- f. Attorneys-in-fact, who sign bid bonds or Contract bonds, must file with each bond, a certified and effectively dated copy of their power of attorney.
- g. The surety company shall familiarize itself with all of the conditions and provisions of this Contract, and it waives the right of special notification of any change or modification of this Contract or of extension of time, or of decreased and increased work, or of the cancellation of the Contract, or of any other act or acts by NOR, or the NOR's authorized agents, under the terms of this Contract; and failure to so notify the aforesaid surety companies of changes shall in no way relieve the surety companies of their obligations under this Contract.

1.08 Proposal Form and Preparation

- a. Bid proposals shall be submitted using the form attached to and forming a part of the Contract Documents. All bid items shall be properly filled out; numbers shall be stated in figures, and the signatures of all persons signing shall be longhand.

- b. Bidder is to complete and submit with the Agreement all certification forms required under Division 0 of these Specifications.

1.09 Prices

- a. In the case of discrepancy between unit prices and totals, unit prices will prevail. In case of discrepancy between words and figures, words will prevail.

1.10 Proposal Guarantee – Bidder’s Bonds

- a. All proposals shall be accompanied by cash, certified check, cashier’s check or Bidder’s Bond made payable to NOR. The Proposal Guarantee must be enclosed in the same envelope with the Proposal. The amount of the Proposal Guarantee shall be not less than 10% of the total amount of the Proposal.

1.11 Address and Marking of Proposals

- a. The envelope containing the Proposal shall be sealed and addressed to NORTH OF THE RIVER RECREATION AND PARK DISTRICT, 3825 Riverlakes Drive, Bakersfield, California 93312. The envelope shall be plainly marked in the upper left-hand corner with the name and address of the Bidder. In the lower left-hand corner the words “PROPOSAL FOR” followed by the name of the Work and the date and hour of opening of bid shall be clearly marked on the envelope. The certified or cashier’s check or Bidder’s Bond shall be enclosed in the same envelope with the Proposal.

1.12 Withdrawals of Proposals

- a. Proposals may be withdrawn by the Bidder prior to the time for opening of bids.
- b. No proposal may be withdrawn after the hour affixed for opening bids without rendering the accompanying certified or cashier’s check or Bidder’s Bond subject to retention. It will be treated as though there is a failure to execute the Contract after it is awarded. Negligence on the part of the Bidder in preparing the Proposal shall not constitute a right to withdraw the Proposal subsequent to the opening of Proposals.

1.13 Lowest Responsible Bidder, Acceptance or Rejection of Proposals

- a. NOR reserves the right to accept or reject any and all Proposals and to waive any informality in any Proposal. No Proposal can be withdrawn during that period.
- b. Before a Proposal is considered for award, NOR may require a Bidder to submit a statement of facts and details as to the business, technical organization, financial resources and equipment available and to be used in performing the work. Additionally, NOR may require evidence that the Contractor has performed other work of comparable magnitude and type. NOR expressly reserves the right to reject any Proposal if it determines that the business and technical organization, equipment, financial and other resources of the Bidder are not sufficiently qualified for the work bid upon and, justifies such rejection.

1.14 Award and Execution of Contract

- a. The Board of Directors and/or General Manager will award the Contract at the prices named in the Proposal to the lowest responsible Bidder no later than during the month following the opening of bids unless all bids are rejected. Contract documents shall be signed within fifteen (15) calendar days after the Bidder receives notice that the contract is ready for signatures. The successful Bidder will be required to execute the Agreement and furnish evidence of insurance and contract bonds as specified in the Contract.

- b. If a Bidder to whom the award is made fails or refuses to so perform as required herein, the respective bid guarantee shall become the property of NOR and the award will be annulled.

1.15 Return of Proposal Guarantee

- a. Within fifteen (15) calendar days after the awarded Contract is executed, NOR will return the proposal guarantees, other than Bidder's Bonds, to all Bidders, whose proposals are not to be further considered in awarding the Contract.
- b. Retained Proposal Guarantees will be held until the Contract has been finally executed, after which all Proposal Guarantees other than Bidder's Bonds and any guarantees which have been forfeited will be returned to the respective Bidders.

END OF SECTION

SECTION 00 25 13 PRE-BID MEETING

NOTICE TO ALL INTERESTED BIDDERS

A **MANDATORY** pre-bid conference will be held on-site on Wednesday, July 1, 2020 at 9:00am PST. Site address is 401 Willow Drive, Bakersfield, California. Interested bidders may set up an individual site visit if needed, but this does not exempt one from the pre-bid walk. Bidders shall meet outside the front entrance to the community center; COVID-19 social distancing and orders will be observed. All questions and RFIs shall be directed to Bid Administrator at bids@norrecreation.org.

Any addenda issued for said bid package will be issued under Section 00 91 13-Addenda.

END OF SECTION

SECTION 00 27 00 BID PROTEST PROCEDURE

1.01 Form and Timing of the Bid Protest.

- a. Any bid protest (a "Bid Protest") must be submitted in writing by an eligible bidder and received by **NORTH OF THE RIVER RECREATION & PARK DISTRICT**, a recreation district operating under California Public Resources Code Section 5781.46 (the "District"), and other persons as specified in Section 4 on or before 5:00 p.m., Pacific Time, on Wednesday, July 15, 2020, i.e., two (2) business days following bid opening (the "Bid Protest Deadline"). A "business" day is a day that is neither a Saturday, a Sunday, nor a federal and/or State of California bank holiday.

1.02. Eligibility to Submit a Bid Protest.

- a. Only a bidder who has actually submitted a Bid Proposal is eligible to submit a Bid Protest against another bidder. Materialmen, subcontractors and suppliers of a bidder are not eligible to submit a Bid Protest. A bidder may not rely on the Bid Protest submitted by another bidder, but must timely pursue its own Bid Protest.

1.03. The Contents of a Bid Protest.

- a. A Bid Protest must contain a complete statement of the basis for the protest and all supporting documentation, information and materials. Documentation, information and materials submitted by the protesting bidder after the Bid Protest Deadline shall not be considered. The Bid Protest must refer to the specific article(s), paragraph(s), portion(s), provision(s) or section(s) of the Contract Documents upon which the Bid Protest is based and/or upon which it relies. The Bid Protest must include the name, address, telephone number and, if available, e-mail address of the person(s) representing the protesting bidder if different from the protesting bidder.

1.04. Submittal of a Bid Protest.

- a. A copy of a Bid Protest and all supporting documentation, information and materials must also be transmitted by e-mail, personal delivery or telefax to the District, the protested bidder and any other bidder who has a reasonable prospect of receiving an award depending upon the outcome of the bid protest prior to the expiration of the Bid Protest Deadline.

1.05. Response to a Bid Protest.

- a. The protested bidder may submit a written response to a Bid Protest (a "Bid Protest Response"). The Bid Protest Response must be received by the District, the protesting bidder and any other bidder who has a reasonable prospect of receiving an award depending upon the outcome of the bid protest on or before 5:00 p.m., Pacific Time, on Friday, July 17, 2020, i.e., two (2) business days following after the Bid Protest Deadline or after receipt of the Bid Protest, whichever is sooner (the "Response Deadline"). The Bid Protest Response must include all supporting documentation, information and materials. Documentation, information and materials submitted by the protested bidder after the Response Deadline shall not be considered. The Bid Protest Response must include the name, address, telephone number and, if available, e-mail address of the person(s) representing the protested bidder if different from the protested bidder.

1.06. Submittal of a Bid Protest Response.

- a. A copy of a Bid Protest Response and all supporting documentation, information and materials must also be transmitted by e-mail, personal delivery or telefax to the District, the protesting bidder and any other bidder who has a reasonable prospect of receiving an award depending upon the outcome of the bid protest prior to the expiration of the Response Deadline.

1.07. Strict Compliance with Procedures and Time Limits.

- a. The procedure and time limits set forth in this Bid Protest Procedure are mandatory and are the bidder's sole and exclusive remedy in the event of a Bid Protest. The protesting bidder's failure to comply with these procedures shall constitute a waiver of any right to further pursue a Bid Protest, including filing a Government Code Claim or initiation of legal proceedings.

1.08. Determination of the Bid Protest by the District.

- a. The District, and more specifically the Board of Directors of the District (the "Board"), shall review all properly and timely submitted Bid Protests and, if applicable, the properly and timely submitted Bid Protest Responses prior to formal award of the bid. The District shall not be required to hold an administrative hearing to consider a timely protest, but may do so at the option of either the Board or the General Manager of the District (the "Manager"), or if otherwise legally required. The Board shall consider a Bid Protest, the Bid Protest Response, if applicable, and the award of the bid within ten (10) days following bid opening. At the time of the Board's consideration of a Bid Protest, the Bid Protest Response, if applicable, and the award of the bid, the Board may also consider the merits of any timely protests and the Manager's recommendation thereon. The Board may either accept the Bid Protest and award the bid to the next lowest responsible bidder, or reject the Bid Protest and award to the lowest responsible bidder. Nothing in these Bid Protest Procedures shall be construed as a waiver of the Board's right to reject all bids. Except as provided in Section 9, the Board's decision is final and not subject to further protest or review.

1.09. Appeal.

- a. Judicial review may be available under administrative mandamus, which is available for review of administrative orders where a hearing is given. (California Code of Civil Procedure Section 1094.5.) Review also may be available under a writ of mandate procedure. (California Code of Civil Procedure Section 1085.)

1.10. Note.

- a. The District must put both construction work and maintenance or repair work costing more than Twenty-Five Thousand Dollars and No Cents (\$25,000.00) out for bids and award the contract to the responsible bidder submitting the lowest responsible bid or reject all bids. The District may perform work estimated to cost less than Twenty-Five Thousand Dollars and No Cents (\$25,000.00) with its own forces or by contract without going out to bid. (California Public Contract Code Sections 20815.1 and 20815.3.)

END OF SECTION

SECTION 00 31 11 PROJECT SUMMARY

North of the River Recreation and Park District is replacing a portion of common area flooring inside Riverview Community Center located 401 Willow Drive. The scope of work shall consist of moisture testing, demo/removal of the existing floor and coving, leveling and treatment to the concrete foundation and the installation of Luxury Vinyl Tile (LVT) and coving, all at prevailing wage rates. An asbestos sample and survey has been completed on the existing tile and mastic; all samples tested were negative. The project materials are specified as such: Hallmark Floors Commercial LVT, Barcelona Spruce, 20 mm thickness, 6" x 48" planks, or approved equal with rubber wall base, color to be brown/cocoa and threshold treatments. The flooring project shall consist of approximately 2,200 square feet within the main lobby, offices, staff area, staff restrooms and hallway, referenced on the floor plan in Section 00 01 15 of the bid, with multiple doorway transitions. An add alternate to this project is including the Multi-Purpose Room, approximately 3,300 square feet, also labeled on the floor plan adjacent to the front lobby; material shall match the main bid.

North of the River Recreation and Park District is observing, understanding and respectful of all social distancing, gathering and working conditions due to COVID-19 executive orders issued by the State of California, CDPH and Kern County Public Health. Through this period of nationwide challenge, our team is committed to our community and our mission.

END OF SECTION

SECTION 00 41 00 BID FORM

To: NORTH OF THE RIVER RECREATION AND PARK DISTRICT

Name of Bidder: _____

Business Address: _____

Business Telephone: _____

Place of Residence: _____

The work to be done is in the State of California, County of Kern, and is to be pursuant to and in accordance with the Plans and Specifications, General Conditions, Special Provisions, Contract and other Contract Documents referred to in the notice published by NOR in The Bakersfield Californian newspaper, and shall consist, in general, of: **Riverview Community Center Flooring Replacement, Project #RV-1-2021.**

The undersigned, as Bidder, declares: That only persons or parties interested in this Proposal as principals are those named herein; the Bidder has no connection with any other parties bidding on the proposed Work (except for a corporate division of the undersigned which may submit an independent bid); that this bid has been prepared and submitted without any collusion, fraud, misrepresentation, or deceit; the Bidder has examined carefully the location of the proposed Work, the proposed form of Agreement and the Plans and Specifications hereinabove referred to; Bidder agrees that if this Proposal is accepted by the NOR's Board of Directors, Bidder will contract with NOR, provide all necessary machinery, tools, apparatus and other means of construction, and do all work and furnish all the materials specified in the above documents in full accordance with the Contract Documents (all within the Contract completion time provided by or agreed to by NOR) and that the Bidder will accept as full payment the amounts set forth in Exhibit "A" attached hereto.

For each item contained in Exhibit "A," the Extension Price has been calculated by multiplying the Estimated Quantity by the Unit Price. The Bid Total is the sum of all Extension Prices. Bidder agrees that in case of any discrepancy between the Unit Price(s) and the respective Extension Prices (s) and/or the Bid Total, the Unit Price(s) shall prevail, and the bid submitted shall be the correctly computed sum of all correctly computed Extension Prices provided. However, if the amount set forth as a Unit Price is unintelligible or omitted, then the amount set forth in the Extension Price column for the item shall be used to determine the correct Unit Price in accordance with the following:

- (1) As to lump sum items, the amount set forth in the Extension Price column shall be the Unit Price.
- (2) As to unit basis item, the amount set forth in the Extension Price column shall be divided by the estimated quantity for the item and the price thus obtained shall be the Unit Price.

If this Proposal is accepted and the undersigned fails to execute the aforesaid Contract and to provide surety bonds and evidence of insurance acceptable to NOR as required within fifteen (15) calendar days after the Bidder receives notice that the Contract is ready for signature, NOR's Board of Directors may, at its option, determine that the Bidder has abandoned the Bid Proposal and the Bidder's security shall be forfeited and shall become the property of NOR. NOR shall then be free to accept the Bid of another Bidder. Should NOR be required to engage the services of an attorney in connection with the enforcement of this Bid, Bidder promises to pay NOR's reasonable attorney's fees, incurred with or without suit.

PROJECT: RV-1-2021

Accompanying this Proposal is (check one) Bid Bond Certified Check in an amount equal to at least ten percent (10%) of the Bid Total.

The names of all persons interested in the foregoing proposal as principals are as follows:

_____	_____
_____	_____
_____	_____

The bidder is licensed in accordance with an act providing for the registration of Contractors, License

Class _____, License No. _____, Expiration Date _____.

Class _____, License No. _____, Expiration Date _____.

Class _____, License No. _____, Expiration Date _____.

California Department of Industrial Relations # _____ **(required)**.

Document 00 43 36, "Proposed Subcontractors Form," is incorporated herein by this reference.

Bidder acknowledges receipt of addenda numbers: _____

Bidder acknowledges receipt and review of complete bid package: _____ (initial)

Dated: _____

Signature of Bidder

SECTION 00 41 00 BID FORM

BID –Riverview Community Center
Flooring Replacement

DUE NO LATER THAN: **July 13, 2020**
2:00pm PST

All line item prices shall include unit cost, tax, freight, and the total.

BID NUMBER: RV-1-2021

IMPORTANT: Show Due Date & Bid Number on face of sealed envelope or subject line of PDF document.

The items included in this bid can be provided within _____ weeks after bid award.

TERMS: Payment will be made when items are satisfactorily received.
Bids may be awarded on a line item basis.

Item No.	Quantity	Description	Unit Price	Extension
1	LS	Moisture and pH Testing.	N/A	\$ _____
2	LS	Demolition and Removal of existing flooring material and adhesive.	N/A	\$ _____
3	LS	Leveling Existing Concrete Foundation.	\$ _____sq.ft	\$ _____
4	LS	Installation: Moisture Barrier.	\$ _____sq.ft	\$ _____
5	LS	Installation: Hallmark Floors Commercial LVT, Barcelona Spruce, 6" X 48", Wearlayer 20 mm thick or approved equal.	\$ _____sq.ft	\$ _____
6	LS	Installation: 4" Rubber Coving Base, Cocoa/Brown or approved equal.	\$ _____ln.ft	\$ _____
7		<u>Total:</u>		\$ _____
Add Alternate #1 – Multi-Purpose Room				
8	LS	Moisture and pH Testing.	N/A	\$ _____
9	LS	Demolition and Removal of existing flooring material and adhesive.	N/A	\$ _____
10	LS	Leveling Existing Concrete Foundation.	\$ _____sq.ft	\$ _____
11	LS	Installation: Moisture Barrier.	\$ _____sq.ft	\$ _____
12	LS	Installation: Hallmark Floors Commercial LVT, Barcelona Spruce, 6" X 48", Wearlayer 20 mm thick or approved equal.	\$ _____sq.ft	\$ _____

PROJECT: RV-1-2021

13	LS	Installation: 4" Rubber Coving Base, Cocoa/Brown or approved equal.	\$ ____ In.ft	\$ _____
14		Total:		\$ _____
Item No.	Description		Start Date	Days to Completion
15	Anticipated/Earliest Start Date and Days to Complete *Estimated Number of Working Days Will Be Used in Determining Bid; Include Lead Time of Materials as Needed.			

NOTE: The return of a signed copy of this form shall constitute a promise to supply or perform the enumerated items subject to the terms & conditions shown.

NOR reserves the right to accept or reject any or all bids or quotations.

If further information is needed contact:
Bid Administrator at bids@norrecreation.org

Make Purchase Order To (firm & address):

 FIRM

 FIRM REPRESENTATIVE SIGNATURE

 REPRESENTATIVE NAME - **PRINTED**

 MAILING ADDRESS

 CITY STATE ZIP

PHONE: _____

SECTION 00 43 00 BID SECURITY FORM

KNOW ALL MEN BY THESE PRESENTS,

That we, _____,

as PRINCIPAL, and _____,

as SURETY (with an "AM Best A-VII" rating or better), are held and firmly bound unto NORTH OF THE RIVER RECREATION AND PARK DISTRICT (hereinafter Obligee), a political subdivision of the State of California, in the penal sum of ten percent (10%) of the total amount of the bid of the Principal above named, submitted by said Principal to Obligee for the Work described below, for the payment of which sum in lawful money of the United States, well and truly to be made, we bind ourselves, our heirs, executors, administrators and successors, jointly and severally, firmly by these presents. In no case shall the liability of the Surety hereunder exceed the sum of \$_____.

THE CONDITION OF THIS OBLIGATION IS SUCH,

THAT WHEREAS THE PRINCIPAL has submitted the above mentioned Bid to Obligee for that certain construction specifically described as follows, for which Bids are to be opened at Bakersfield, California, on _____ for _____

NOW, THEREFORE, if the aforesaid Principal is awarded the Contract and within the time and manner required under the Specifications, after the prescribed forms are presented to him for signature, enters into a written Contract, in the prescribed form, in accordance with the Bid, and files the two bonds with the Obligee, one to guarantee faithful performance and the other to guarantee payment for labor and materials, as required by law, and furnishes the required certifications of insurance, and such other required certificates, then this obligation shall be null and void; otherwise, it shall remain in full force and virtue.

In the event suit is brought upon this Bond by the Obligee and Judgement is recovered, the Surety shall pay all costs incurred by the Obligee in such suit, including a reasonable Attorney's fee to be fixed by the Court.

IN WITNESS WHEREOF, we have hereunto set our hands and seals on this ____ day of _____, 20____ A.D.

_____(SEAL)

_____(SEAL)

_____(SEAL)

_____(SEAL)

_____(SEAL)

_____(SEAL)

PRINCIPAL

SURETY

PROJECT: RV-1-2021

Correspondence or claims related to this bond should be sent to the Surety at the following address:

NOTE: Signatures of those executing for Surety must be properly acknowledged. A certified copy of the surety's power of attorney shall be attached to this form.

COMPLETE AND SUBMIT WITH BID

END OF SECTION

SECTION 00 43 36 PROPOSED SUBCONTRACTORS FORM

Each Bidder shall set forth below: (a) the required information for each Subcontractor who will perform work or labor, fabricate a portion of the Work or improvement according to detailed Drawings in the Project Plans, or render service to the Contractor in or about the construction of the Work in an amount in excess of one-half of one percent ($\frac{1}{2}$ of 1%) of the Contractor's total bid; and (b) the portion of the Work which will be done by each such Subcontractor. If the Contractor fails to specify a Subcontractor for any portion of the Work as above stated, said Contractor agrees to perform the Work exclusively. In accordance with Section 4101 to Section 4207, inclusive, of the Government Code of the State of California as amended, the following is submitted concerning Subcontractors:

<u>Name of Subcontractor</u>	<u>Address of Shop/Mill/Office</u>	<u>*License Number</u>	<u>Exp. Date</u>	<u>Portion of Work To be Done</u>

NAME OF CONTRACTOR: _____

(*The license information may be added within 24 hours of bid opening if it was not available at the time the bid was submitted.)

COMPLETE AND SUBMIT WITH BID
(Attach Additional Pages If Needed to List All Subcontractors)

END OF SECTION

**SECTION 00 43 93
BID SUBMITTAL CHECKLIST**

Documents to Be Received with Bid Package:

- 00 41 00 Bid Form
- 00 25 13 Pre-Bid Meeting Attendance/Site Visit (IF APPLICABLE)
- 00 43 00 Bid Security Form
- 00 43 36 Proposed Subcontractors Form
- 00 45 13 Bidder's Qualifications
- 00 45 19 Non-Collusion Affidavit
- 00 45 26 Workers' Compensation Certification
- 00 45 33 Non-Segregated Facilities Certification
- 00 45 36 Equal Employment Opportunity and Prevailing Wage Compliance Certification
- 00 45 37 Certification of Performance on Previous Equal Employment Opportunity Contracts
- 00 91 13 Addenda Received (if applicable)

END OF SECTION

SECTION 00 45 13 BIDDER'S QUALIFICATIONS

QUALIFICATIONS

In accordance with Instructions to Bidders, Item 1.05 "Qualifications of Contractors", paragraph a., the Bidder is to state their qualifications hereon, or attached to, this form.

<u>NAME OF PROJECT</u>	<u>LOCATION</u>	<u>DESCRIPTION</u>	<u>CONTACT NAME, PHONE NUMBER</u>

CONTRACTOR'S NAME: _____

CONTRACTOR'S LICENSE #: _____

TYPE OF LICENSE: _____

SIGNED: _____

TITLE: _____

COMPLETE & SUBMIT WITH BID

END OF SECTION

**SECTION 00 45 19
NON-COLLUSION AFFIDAVIT**

State of California)
)ss.
County of Kern)

I, _____, being first duly sworn, deposes and says that he or she
(Name of individual representing bidder)

is _____ of _____, the party making
(Title) (Name of Bidder)

the foregoing bid that the bid is not made in the interest of, or on behalf of, any undisclosed person, partnership, company, association, organization or corporation; that the bid is genuine and not collusive or sham; that the bidder has not directly or indirectly induced or solicited any other bidder to put in a false or sham bid, and has not directly or indirectly colluded, conspired, connived or agreed with any bidder or anyone else to put in a sham bid, or that anyone shall refrain from bidding; that the bidder has not in any manner, directly or indirectly, sought by agreement, communication or conference with anyone to fix the bid price of the bidder or any other bidder, or to fix any overhead, profit, or cost element of the bid price, or of that of any other bidder, or to secure any advantage against the public body awarding the contract of anyone interested in the proposed contract; that all statements contained in the bid are true; and further, that the bidder has not, directly or indirectly, submitted his or her bid price or any breakdown thereof, or the contents thereof, or divulged information or data relative thereto, or paid, and will not pay, any fee to any corporation, partnership, company association, organization, bid depository, or to any member or agent thereof to effectuate a collusive or sham bid.

Contractor/Subcontractor/Consultant Business Address

Signature Business City, State, Zip

Title Residence Address

A notary public or other officer completing this certificate verifies only the identity of the individual who signed the document to which this certificate is attached, and not the truthfulness, accuracy, or validity of that document.

State of California
County of _____

Subscribed and sworn to (or affirmed) before me on this _____ day of _____, 20_____.

by _____ proved to me on the basis of satisfactory evidence to be
the person(s) who appeared before me.

Signature of Notary

(Seal)

(TO BE EXECUTED BY BIDDER AND SUBMITTED WITH BID)

END OF SECTION

SECTION 00 45 26
WORKERS' COMPENSATION CERTIFICATION

In accordance with Section 1861 of the Labor Code, "I am aware of the provisions of Section 3700 of the Labor Code which require every employer to be insured against liability for worker's compensation or to undertake self-insurance in accordance with the provisions of that code, and I will comply with such provisions before commencing the performance of the work of this contract."

I/We certify to the Owner, North of the River Recreation and Park District (NOR), that our company is in compliance with this requirement:

CONTRACTOR

SIGNATURE

TITLE

DATE: _____

COMPLETE AND SUBMIT WITH BID

END OF SECTION

SECTION 00 45 33
NON-SEGREGATED FACILITIES CERTIFICATION

The Contractor certifies that it does not and will not maintain or provide for its employees any segregated facilities at any of its establishments, and that it does not and will not permit its employees to perform their services in any location, under its control, where segregated facilities are maintained. The Contractor agrees that a breach of this certification is a violation of the equal opportunity clause in this contract. As used in this certification, the term "segregated facilities" means any waiting room, work areas, restrooms and washrooms, restaurants and other eating areas, time clocks, locker rooms and other storage or dressing areas, parking lots, drinking fountains, recreation or entertainment areas, transportation, and housing facilities provided for employees which are segregated by explicit directive or are in fact segregated on the basis of race, color, religion, sex or national origin because of habit, local custom, or any other reason. The Contractor agrees that (except where it has obtained identical certifications from proposed subcontractors for specific time periods) it will obtain identical certifications from proposed subcontractors prior to the award of subcontracts exceeding \$10,000 which are not exempt from the provisions of the equal opportunity clause, and that it will retain such certifications in its files.

Project Name and Number: **Riverview Community Center Flooring Replacement, #RV-1-2021.**

CONTRACTOR/SUBCONTRACTOR

DATED: _____

BY: _____

TITLE: _____

COMPLETE AND SUBMIT WITH BID

END OF SECTION

**SECTION 00 45 36
EQUAL EMPLOYMENT OPPORTUNITY AND
PREVAILING WAGE COMPLIANCE CERTIFICATION**

I hereby certify that I will comply with all the provisions of the Equal Opportunity Clause of Executive Order 11246 as amended by Executive Order 11375. Contractor agrees that no person, on the grounds of race, color, religion, national origin, sex or age will be subjected to discrimination under this contract.

I hereby certify further that I will conform to the general prevailing wage determinations made by the director of industrial relations pursuant to California Labor Code part 7, chapter 1, article 2, sections 1770, 1773, and 1773.1 regarding wages, benefits, on-site audits with 48 hour notice, payroll records, submittal of weekly payrolls (when requested) to North of the River Recreation and Park District and apprentice and trainee employment requirements.

I hereby certify further that I have been notified of California Department of Industrial Relations requirements for the registration of contractors and subcontractors; that the project is subject to compliance monitoring and enforcement by the Department of Industrial Relations; and the posting of job site notices prescribed by regulation. Pursuant to California Labor Code part 7, chapter 1, article 2, sections 1725.5, 1771.1 and 1771.4.

Project Name and Number: **Riverview Community Center Flooring Replacement, #RV-1-2021.**

California Department of Industrial Relations Number: _____

CONTRACTOR/SUBCONTRACTOR

DATED: _____

BY _____

SIGNATURE

TITLE _____

COMPLETE AND SUBMIT WITH BID

END OF SECTION

SECTION 00 45 37
PERFORMANCE ON PREVIOUS EQUAL EMPLOYMENT OPPORTUNITY
SUBJECT CONTRACTS/SUBCONTRACTS CERTIFICATION

The bidder, _____, and its proposed subcontractor(s),

hereby certify that they have/have not (circle one), participated in a previous contract or subcontract subject to the equal opportunity clause, as required by Executive Orders 10925, 11114, or 11246, and that they have/have not (circle one), filed with the Joint Reporting Committee, the Director of the Office of Federal Contract Compliance, a Federal Government contracting or administering agency, or the former President's Committee on Equal Employment Opportunity, all reports due under the applicable filing requirements.

Project Name and Number: **Riverview Community Center Flooring Replacement, #RV-1-2021.**

CONTRACTOR/SUBCONTRACTOR

DATE _____ BY _____
TITLE _____

NOTE: The above certification is required by the Equal Employment Opportunity Regulations of the Secretary of Labor [41 C.F.R. 60-1.7 (b)(1)], and must be submitted by bidders and proposed subcontractors only in connection with contracts and subcontracts which are subject to the equal opportunity clause. Contracts and subcontracts which are exempt from the equal opportunity clause are set forth in 41 C.F.R 60-1.5. (Generally only contracts or subcontracts of \$10,000 or under are exempt).

Currently, Standard Form 100 (EEO-1) is the only report required by the Executive Orders of their implementing regulations.

Proposed prime contractors and subcontractors who have participated in a previous contract or subcontract subject to the Executive Orders and who have not filed the required reports should note that 41 C.F.R. 60-1.7 (b) (1) prevents the award of contracts and subcontracts unless such contractor submits a report covering the delinquent period or such other period specified by the Federal Highway Administration or by the Director, Office of Federal Contract Compliance, U.S. Department of Labor.

COMPLETE AND SUBMIT WITH BID

END OF SECTION

SECTION 00 52 00 AGREEMENT FOR CONSTRUCTION

THIS AGREEMENT made _____, 20___, between NORTH OF THE RIVER RECREATION AND PARK DISTRICT, a California Special District operating under Public Resource Code Section 5780 (herein, "NOR"), and _____, a _____ (herein, "Contractor"), whose address is _____, registered as # _____ with the California Department of Industrial Relations.

WITNESSETH:

ARTICLE I. In consideration for the promises and payment(s) to be made and performed by NOR, and under the conditions expressed in the incorporated Proposal ("Bid") and Contract Documents, Contractor agrees to do all the work and furnish all the materials at the expense of Contractor (except such as the Contract Documents state will be furnished by NOR) necessary to construct and complete in a good and workmanlike manner to the satisfaction of NOR, and as further shown and described in the Drawings and Specifications entitled: _____.

The work, for which Contractor submitted and NOR accepted a proposal total of \$ _____, will be completed within the time limit specified in the Supplementary Conditions, in conformity with Contract Documents incorporated by Article III of this Agreement.

ARTICLE II. Contractor agrees to accept the total amount or the unit prices, as the case may be, listed in the accepted proposal as full payment for all materials and all work embraced in this Agreement including all loss and damage arising out of the Work or the action of the elements or any unforeseen difficulties or obstructions which may arise or be encountered in the prosecution of the Work and for all risks of every description connected with the Work and for all expenses incurred by or in consequence of the suspension or discontinuance of work and for well and faithfully completing the work in the manner and time and according to the Contract Documents and any changes in the Contract Documents NOR may authorize. NOR employs Contractor to provide the materials and do the work according to the terms and conditions of this Agreement, for the prices stated, and will pay the agreed price in the manner set out in the General Conditions, Supplementary Conditions and Specifications.

ARTICLE III. The Invitation to Bid, Instruction to Bidders, General Conditions, Supplementary Conditions, Drawings, Specifications, Bid Proposal, Addenda, and Bonds (copies of which are attached to this Agreement and are on file in NOR's Administrative Center) are by these references incorporated in this Agreement and comprise the Contract Documents.

ARTICLE IV. I (Contractor) am aware of the provisions of Section 3700 of the Labor Code which requires every employer to be insured against liability for workers' compensation or to undertake self-insurance in accordance with provisions of that Code, and I will comply with such provisions before commencing the performance of the Work of this Contract.

Signature of Contractor's Authorized Representative Making
the Above-Stated Certification

ARTICLE V. In the event suit is brought to enforce or interpret any part of this Contract, the “prevailing party” shall be entitled to recover as an element of the costs of suit, and not as damages, reimbursement of costs and a reasonable attorney’s fee plus expenses (including the cost of Engineer and NOR’s representatives and experts and investigators) to be fixed in Court. The “prevailing party” shall be the party who is entitled to recover costs of suit, whether or not the suit proceeds to final judgement. A party not entitled to recover costs shall not recover attorney’s fees. No sum for attorney’s fees shall be counted in calculating the amount of a judgement for purposes of determining whether a party is entitled to recover costs or attorney’s fees.

ARTICLE VI. If NOR or its officers, agents, consultants, employees and Engineer are named, or are required to testify, or to contribute time and expense in any other way, in any suit or enforcement action of any kind brought to recover alleged damages or remedy alleged violations resulting from the acts or omissions (including negligent acts or omissions) in connection with, or accidents arising from, the acts, operations, and responsibilities of the Contractor or others associated with or working under Contractor, or others to whom the Contractor is responsible in direct or indirect relation to the performance of the Contract work, NOR and/or its officers, agents, consultants, employees, and Engineers shall be held financially harmless and legally defended (with counsel acceptable to the named party) by the Contractor from any claims for damages and reimbursed for any reasonable costs incurred by them for lost time, expert assistance, and incidental expenses in connection with their need to participate in defending themselves against such claims, or contributing time and expense in any other such way, whether or not the suit or enforcement action proceeds to final judgement. This article shall apply and be enforceable for the full time of any applicable statute of limitations.

ARTICLE VII. The parties do for themselves, their heirs, executors, administrators, successors, and assigns agree to the full performance of all the provisions herein contained. Contractor may not, either voluntarily or by action of law, assign any obligation assumed by Contractor hereunder without the prior written consent of NOR.

IN WITNESS WHEREOF, NOR and Contractor have set their hands on the date first above written.

NORTH OF THE RIVER RECREATION AND PARK DISTRICT

Date: _____ by _____
SIGNATURE

Contractor's Name

Contractor's License Number

Type of Entity (corporation, partnership, individual, etc.)

Date: _____ by _____
Signature

Print Name

Title of Individual Executing Document on Behalf of Firm

NOTICE: Contractors are required by law to be licensed and regulated by the Contractors State License Board. Questions concerning a contractor may be referred to the registrar of that board.

END OF SECTION

SECTION 00 61 13 FAITHFUL PERFORMANCE BOND

KNOW ALL MEN BY THESE PRESENTS

THAT, WHEREAS, North of the River Recreation and Park District (NOR) has entered into a contract dated _____ with _____ hereinafter designated as the "Contractor," for the work described as: _____.

WHEREAS, the said Contractor is required under the terms of said Contract to furnish a bond for the faithful performance of said Contract;

NOW, THEREFORE, WE, the undersigned Contractor, as Principal and _____ (Corporate Surety with an "AM Best A-VII" rating or better), a corporation organized and existing under the laws of the State of _____, and duly authorized to transact business under the laws of the State of California, as SURETY are held and firmly bound unto NOR in the penal sum of \$ _____ lawful money of the United States, said sum being not less than one hundred percent (100%) of the total Contract amount, for the payment of which sum well and truly to be made, we bind ourselves, our heirs, executors, administrators, and successors, jointly and severally, firmly by these presents.

THE CONDITION OF THIS OBLIGATION IS SUCH THAT IF the above bounden Contractor or its heirs, executors, administrators, successors or assigns, shall in all things stand to and abide by, well and truly keep and perform the covenants, conditions, and agreements of said Contract and any alterations thereof made as therein provided on its part, to be kept and performed at the time and in the manner therein specified, and in all respects according to their true intent and meaning, and shall indemnify and save harmless NOR, its officers and agents, as therein stipulated, then this obligation shall become null and void; otherwise it shall be and remain in full force and virtue. In the event legal action is required to enforce the provisions of this Agreement, the prevailing party shall be entitled to recover reasonable attorney's fees in addition to court costs, necessary disbursements, and other damages.

And the said SURETY, for value received, hereby stipulates and agrees that no charge, extension of time, alteration, or addition to the terms of the Contract or to the Work to be performed thereunder or the Specifications accompanying the same shall in any wise effect its obligations on this bond, and it does hereby waive notice of any such change, extension of time, alteration, or addition to the terms of the Contract or to the Work or to the Specifications.

IN WITNESS WHEREOF, we have hereunto set our hands and seals this ____ day of _____,
20__.

CONTRACTOR AS PRINCIPAL

BY _____

(Corporate Seal)

TITLE: _____

SURETY

BY: _____

TITLE: _____

Correspondence or claims related to this bond should be sent to the Surety at the following address:

Phone Number: _____

NOTICE: The acknowledgment of an authorized representative of the principal and a certified copy of the surety's power of attorney shall be attached to this form.

SUBMIT WITH AGREEMENT

END OF SECTION

SECTION 00 61 13. 16 PAYMENT BOND

KNOW ALL MEN BY THESE PRESENTS

THAT, WHEREAS, North of the River Recreation and Park District (NOR) has awarded to: _____, hereinafter designated as the "Contractor," a Contract for the Work described as follows: _____.

WHEREAS, said Contractor is required by the provisions of Division 3, Part 4, Title 15, Chapter 7 of the Civil Code to furnish a bond in connection with said Contract, as hereinafter set forth.

NOW, THEREFORE, WE, the undersigned Contractor as principal and _____ (Corporate Surety with an "AM Best A-VII" rating or better) a corporation organized and existing under the laws of the State of _____ and duly authorized to transact business under the laws of the State of California, as SURETY are held and firmly bound unto NOR under the terms and truly to be made we bind ourselves, our heirs, executors, administrators, and successors, jointly and severally, firmly by these presents in the penal sum of \$ _____. This being at least fifty percent (50%) of the total Contract amount herein \$ _____, paid in lawful money of the United States.

THE CONDITION OF THIS OBLIGATION IS SUCH THAT, if said Contractor, or its heirs, executors, administrators, successors, assigns or subcontractors shall fail to pay for any materials, provisions, provender, or other supplies or teams, implements, or machinery used in, upon, for or about the performance of the Work contracted to be done, or for any work or labor thereon of any kind, or fail to pay any of the persons named in California Civil Code Section 3181, or for the amounts due under the Unemployment Insurance Code with respect to work or labor performed under the Contract, or for any amounts required to be deducted, withheld, and paid over to the Employment Development Department from the wages of employees of the Contractor and Subcontractors pursuant to Section 13020 of the Unemployment Insurance Code with respect to such work or labor as required by the provisions of Division 3, Part 4, Title 15, Chapter 7 of the Civil Code; and provided that the claimant shall have complied with the provisions of said Code, the surety or sureties hereon will pay for the same in an amount not exceeding the sum specified in this bond, otherwise the above obligation shall be void. In case suit is brought upon this bond, the said Surety will pay a reasonable attorney's fee to be fixed by the Court.

This bond shall inure to the benefit of any and all persons, companies, and corporations entitled to file claim under Section 3181 of the Civil Code, so as to give a right of action to them or their assigns in any suit brought upon this bond. And the said SURETY, for value received, thereby stipulates and agrees that no change, extension of time, alteration or addition to the terms of the Contract or to the Work to be performed thereunder or the Specifications accompanying the same shall in any wise affect its obligations on this bond and it does hereby waive notice of any such change, extension of time, alteration or addition to the terms of the Contract or to the Work or to the Specifications.

Principal and SURETY agree that should NOR become a party to any action on this bond that each will also pay NOR's reasonable attorney's fees included therein in addition to the sum above set forth.

IN WITNESS WHEREOF, WE have hereunto set our hands and seals this _____ day of _____, 20__.

CONTRACTOR AS PRINCIPAL

BY _____

(Corporate Seal)

TITLE _____

SURETY

BY _____

TITLE _____

Correspondence or claims related to this bond should be sent to the Surety at the following address:

Phone number: _____

NOTICE: The acknowledgment of an authorized representative of the principal and a certified copy of the surety's power of attorney shall be attached to this form.

SUBMIT WITH AGREEMENT

END OF SECTION

**SECTION 00 62 24
CERTIFICATE OF EXCLUSION OF
ASBESTOS AND LEAD PRODUCTS**

**Project: Riverview Community Center
Flooring Replacement
401 Willow Drive
Bakersfield, CA**

EXCLUSION OF ASBESTOS and LEAD CONTAINING PRODUCTS
TO BE EXECUTED BY CONTRACTOR

1. The General Contractor agrees that asbestos and lead containing products or materials will not be used in performing work under the Agreement for the above referenced project.
2. At the completion of work under the Agreement, the General Contractor will represent to Owner, North of the River Recreation and Park District, that to the best of the Contractor's knowledge, opinion or belief, no asbestos and lead containing products or materials were used in performing work under the Agreement.

Executed at _____, California, on _____, 20_____.

Contractor

Signature

Type Name and Title

SUBMIT WITH AGREEMENT

END OF SECTION

SECTION 00 63 13 REQUEST FOR INFORMATION FORM

Project: Riverview Community Center
Flooring Replacement
To: North of the River Recreation & Park District
Re: _____

R.F.I. #: _____
From: _____
Date: _____
Proj. #: _____

Specification Section: _____ Paragraph: _____ Drawing Sheet: _____ Detail: _____
Request: _____

Signed By: _____ Printed Name: _____ Date: _____
Response: _____

Attachments:

Response From: _____ To: _____ Date Rec'd: _____ Date Ret'd: _____
Signed by: _____ Printed Name: _____ Date: _____
Copies: Owner Consultants File _____

END OF SECTION

SECTION 00 65 36 WARRANTY FORM

For a valuable consideration, the receipt of which is hereby acknowledged, we guarantee that the labor and materials which we have supplied and/or furnished and/or constructed and/or installed and/or performed at _____ Bakersfield, California, are in accordance with specifications and plans for said construction project prepared by North of the River Recreation and Park District (NOR) and conform to the specific requirements, performances, and capacities set forth in all of the contract documents, plans and specifications for said project and will fulfill the requirements of the guaranties included in the said specifications, plans and contract documents.

We further guarantee the same to be free from imperfect workmanship and/or materials, and we agree to repair and/or replace at our own cost and expense any and all such work and/or materials which may prove defective in workmanship or materials within a period of one (1) year from date of acceptance of the above named construction project by NOR, ordinary wear and tear, unusual abuse or neglect excepted. We also agree to repair and/or replace at our own cost and expense any work and/or materials that we may disturb or displace in making good such defects.

Within twenty-four (24) hours after being notified in writing by NOR of any defects in said work or materials, we agree to commence and prosecute with due diligence all work necessary to fulfill the terms of this guaranty and to complete the work within a reasonable period of time and in the event of our failure to so comply we collectively and expressly do hereby authorize NOR to proceed to have such work done at our expense and we will honor and pay the cost and charges therefore upon demand.

This guarantee is made expressly for and runs to the benefit of NOR and shall be enforceable by NOR.

DATED: _____
Contractor

By: _____
Signature

Typed Name and Title

For maintenance, repair, or replacement service contact:

Name: _____

Address: _____ Phone: _____

SUBMIT WITH AGREEMENT

END OF SECTION

SECTION 00 72 00
INDEX
GENERAL CONDITIONS OF THE CONTRACT

CONTRACT DOCUMENT PLANS & SPECIFICATIONS SITE INVESTIGATION

- 1.01 Correlation & Intent of Documents
- 1.02 Interpretation of Plans & Specifications
- 1.03 Site Investigation

CONSTRUCTION FACILITIES AND TEMPORARY CONTROLS

- 1.04 Contractor's Facilities
- 1.05 Temporary Use of Facilities
- 1.06 Sanitary Facilities
- 1.07 Utilities for Construction
- 1.08 Fencing of the Construction Area
- 1.09 Illumination
- 1.10 Lands for Work, Right of Way Easements & Access Roads
- 1.11 Protection of Work
- 1.12 Preservation of Property
- 1.13 Protection of Roadways from Excess Loadings
- 1.14 Responsibility for Repair of Facilities
- 1.15 Traffic Control
- 1.16 Public Convenience

SAFETY

- 1.17 Safety
- 1.18 Accidents
- 1.19 Fire Protection
- 1.20 Valley Fever - Notice to Employees
- 1.21 COVID-19

INSURANCE AND LIABILITY

- 1.22 Insurance
- 1.23 Indemnity and Litigation Costs

LABOR REQUIREMENTS

- 1.24 Labor Discrimination Prohibited
- 1.25 Mandatory Certification of Contractor and Employment of Apprentices
- 1.26 Prevailing Rates of Wages and Payroll Records
- 1.27 Eight-Hour Day Limitation
- 1.28 Worker Benefits

MATERIALS AND EQUIPMENT

- 1.29 Materials Furnished by the Contractor
- 1.30 Records of Materials Purchased

- 1.31 Material Storage and Protection
- 1.32 Right to Operate Unsatisfactory Equipment or Facilities
- 1.33 Warranty
- 1.34 Trade Names or Approved Equals
- 1.35 Submittals
- 1.36 Requirements Described Elsewhere
- 1.37 Schedule of Submittals
- 1.38 Samples
- 1.39 Colors
- 1.40 Shop and Fabrication Drawings
- 1.41 Record Drawings
- 1.42 Manuals

PROGRESS AND COMPLETION - TERMINATION

- 1.43 Progress and Completion of Work
- 1.44 Progress Schedule and Order of Completion
- 1.45 Contractor's Forces, Equipment and Progress
- 1.46 Failure to Complete the Work in the Time Agreed Upon
- 1.47 Use of Completed Portions, Right to Operate Facilities
- 1.48 Time of Work - Termination for Delay - Time Extensions
- 1.49 Termination for Reasons Other Than Delivery

QUALITY CONTROL OF THE WORK

- 1.50 Assignment
- 1.51 Superintendence - Personal Attention
- 1.52 Legal Address of Contractor
- 1.53 Authority of NOR
- 1.54 Inspection of Work
- 1.55 Compliance With Laws - Permits, Regulations, Taxes
- 1.56 Correction of Work
- 1.57 Cleanup

MEASUREMENT & PAYMENT

- 1.58 Scope of Payment
- 1.59 Measurement of Quantities
- 1.60 Progress Estimates and Payments
- 1.61 Payment of Taxes
- 1.62 Warranty of Title
- 1.63 Satisfaction of Liens
- 1.64 Waiver of Interest
- 1.65 Disputes
- 1.66 Right to Withhold Payments
- 1.67 Claims for Extra Work
- 1.68 Extra Work
- 1.69 Final Acceptance and Date of Completion
- 1.70 Final Payment
- 1.71 Final Release

SECTION 00 72 00 GENERAL CONDITIONS OF THE CONTRACT

CONTRACT DOCUMENTS, PLANS, SPECIFICATIONS & SITE INVESTIGATION

1.01 Correlation and Intent of Documents

- a. The intent of the Contract Documents is to prescribe the details for the construction and completion of the Work which the Contractor undertakes to perform in accordance with the terms of the Contract Documents and to require a complete and finished piece of work. Where the Plans and Specifications describe portions of the Work in general terms, but not in complete detail, it is understood that only the best general practice is to prevail and that only materials and workmanship of first quality are to be used. Unless otherwise specified, the Contractor shall furnish all labor, materials, tools, equipment and incidentals, and do all the Work involved in executing the Contract in a satisfactory and workmanlike manner.
- b. The Contract Documents are complementary, and what is required in any one shall be as binding as if specified in all.
- c. The organization of the Specifications into divisions, sections and articles, and the arrangement of Drawings shall not control the Contractor in dividing the Work among Subcontractors or in establishing the extent of work to be performed by any trade.

1.02 Interpretation of Plans and Specifications

- a. Every part of the Work, as shown on the Drawings and described in the Specifications, must be complete and finished. No deviations are to be made from the Drawings or Specifications without previous written authorization from NOR.
- b. In general, the Drawings show dimensions, positions, and kind of construction and the Specifications define materials, qualities and methods. In the event that work is called for on the Drawings and not in the Specifications, or vice versa, the Contractor shall immediately notify NOR of the omission, and wait for NOR to issue instructions for procedure. Upon receiving such instruction, the Contractor shall be responsible for performing any work originally called for on the Drawings and not in the Specifications or vice versa, as though fully set forth in both.
- c. In the case of difference between the Specifications and Drawings, the Specifications shall govern. However, whenever the Contractor observes an error or conflict in the Drawings or Specifications, or in the work done by others affecting this Work, the Contractor shall immediately notify NOR of the discrepancy and wait for NOR to issue instructions to proceed. If the Contractor proceeds with the affected work without instructions from NOR, any resulting damages or defects shall be made good. This includes typographical errors in the Specifications and notational errors on the Drawings.
- d. The Drawings must accurately be followed as to scale, except where figures are given for dimensions, which shall in all cases be taken in preference to scale measurements. Large scale details take precedence over small drawings in all cases.
- e. Work not particularly detailed, marked or specified shall be the same as similar parts that are detailed, marked or specified. Where a portion of the Work is detailed on any drawings and the remainder is indicated in outline, the detailed parts shall apply also to all like portions of the Work. Where ornament or other detail is indicated only partially, the detail shall be continued through the sections

or parts in which it occurs and shall also apply to all similar parts in the Work, unless otherwise indicated.

1.03 Site Investigation

- a. The Contractor acknowledges sufficient site investigation to reach satisfaction as to the nature and location of the Work, the general and local conditions, particularly those bearing on transportation, handling and storage of materials, the character of the equipment and facilities needed during the prosecution of the Work and all other matters which can in any way affect the Work or the cost thereof under this Contract. Any failure of the Contractor to be acquainted with all the available information concerning these conditions will not relieve it from the responsibility for estimating properly the difficulties or cost of successfully performing the Work.

CONSTRUCTION FACILITIES AND TEMPORARY CONTROLS

1.04 Contractor's Facilities

- a. Before proceeding with the erection of any construction facilities, including machinery, equipment, offices, or warehouses, the Contractor shall, at no expense to NOR, notify and furnish NOR with information and drawings as NOR may request for all such facilities, with capacities and capabilities of the machinery and equipment. Such Contractor's facilities shall be adequate for the uses intended and be fully in accord with the requirements of the Contract.

1.05 Temporary Use of Facilities

- a. Subject to the approval of NOR, the Contractor may be permitted to make temporary use of NOR owned land or storage areas available in the vicinity of the Contract Work for storage of equipment or materials. The Contractor shall obtain approval for use of facilities prior to bidding. If such permission is not obtained prior to bidding there is no guarantee that this can happen and the Contractor is responsible to pay all additional costs incurred as a result of not properly securing permission prior to bidding.

1.06 Sanitary Facilities

- a. Furnish and install all required temporary toilet buildings with sanitary toilets for use of all employees. Comply with all minimum requirements of the Health Department or other public agency having jurisdiction. Maintain in a usable sanitary condition at all times.

1.07 Utilities for Construction

- a. The Contractor shall, at no expense to NOR, arrange for, develop, and maintain all utilities necessary for the performance of Work under the Contract, including all interest in land necessary therefore. Such service shall be furnished at the Contractor's expense. At sites where utilities exist NOR may furnish utilities at no expense to the Contractor. Contractor is responsible to determine availability of adequate services and receive approval of NOR to use the same prior to submitting a bid for the work. Any misjudgment on the part of the Contractor shall be corrected at the Contractor's expense.

1.08 Fencing of the Construction Area

- a. If fencing is required for the construction, furnish and install a temporary fence around the construction area as indicated on the Drawings. Temporary fencing shall not be less than six feet high, complete with metal or wood posts, a woven wire mesh and all required bracing, truck gates, and pedestrian gates. Where there is existing fencing it may be utilized in the project fencing unless the height or condition of the existing fence will not meet the intent of the construction fence.

1.09 Illumination

- a. When any work is performed at night or where daylight is shut off or obscured, the Contractor shall, at no expense to NOR, provide artificial light sufficient to permit work to be carried on efficiently, satisfactorily and safely, and to permit thorough inspection. The access to the place of work shall also be clearly illuminated.

1.10 Lands for Work, Right of Way Easements and Access Roads

- a. NOR will provide the lands, easements and rights of way or other right to enter and work on lands necessary for the performance of the Work. Should the Contractor find it advantageous to use any additional land for any purpose whatever, the Contractor shall provide for the use of such land at its expense. Nothing herein contained and nothing marked on the Drawings, shall be interpreted as giving the Contractor exclusive occupancy of the territory provided by NOR. When two or more contracts are being executed at one time on the same or adjacent land in such a manner that work on one contract may interfere with that of another, NOR shall decide which contractor shall cease work and which shall continue, or whether the work on both contracts shall progress at the same time, and in what manner, and the decision of NOR shall be final and binding.
- b. Lands to be furnished by NOR for construction operations will be specifically shown on the Drawings or provided for in the Supplementary Conditions.
- c. The Contractor, if required, shall construct and maintain all roads necessary to reach the various parts of the Work and for the transportation thereto of construction material and personnel. The cost of constructing and maintaining such roads shall be borne by the Contractor.

1.11 Protection of Work

- a. Until acceptance of the Work by NOR, the Contractor shall continuously maintain adequate protection of all work from damage. The Contractor shall make good any such damage, injury, or loss, except such as may be caused solely by the negligence or willful misconduct of agents and employees of NOR. Contractor shall adequately protect adjacent property as provided by law and the Contract Documents. Contractor shall provide and maintain all passageways, guard fences, lights and other facilities for protection required by public authority or local conditions.
- b. The Contractor shall be responsible for all damage to any property resulting from trespass by the Contractor or employees of the Contractor in the course of their employment, whether such trespass was committed with or without the consent or knowledge of the Contractor.

1.12 Preservation of Property

- a. The Contractor shall take whatever precautions are necessary to prevent damage to all existing improvements, including aboveground and underground utilities, trees, and shrubbery that are not specifically shown to be removed, fences, signs, mailboxes, survey markers and monuments, buildings and structures, NOR's property, adjacent property, and any other improvements or facilities within or adjacent to the work. If such improvements or property are injured or damaged by reason of the Contractor's operations, they shall be replaced or restored, at the Contractor's expense, to a condition at least as good as the condition that existed prior to the start of the Contractor's operations.
- b. The Contractor shall examine all bridges, culverts and other structures over which materials and equipment will be moved, before using them, and shall properly strengthen such structures, where

necessary. The Contractor shall be responsible for any and all injury or damage to such structures caused by reason of construction operations.

c. Regional Notification Center Contact:

- (1) Contractor, except in an emergency, shall contact the appropriate regional notification center at least two working days prior to commencing any excavation if the excavation will be conducted in an area or in a private easement which is known, or reasonably should be known, to contain subsurface installations other than any underground facilities owned or operated by NOR, and obtain an inquiry identification number from that notification center. No excavation shall be commenced and/or carried out by the Contractor unless such an inquiry identification number has been assigned to the Contractor or any Subcontractor of the Contractor and NOR has been given the identification number by the Contractor.
- (2) "Emergency" shall be defined as a sudden, unexpected occurrence, involving a clear and imminent danger, demanding immediate action to prevent or mitigate loss of, or damage to life, health, property, or essential public services. Emergency includes such occurrences as fire, flood, earthquake, or other soil or geologic movements, as well as such occurrences as riot, accident, or sabotage (Government Code Section 4216).
- (3) "Subsurface installation" means any underground pipeline, conduit, duct, wire, or other structure operated or maintained in or across a public street or public right-of-way (Government Code Section 4216).

1.13 Protection of Roadways from Excess Loadings

- a. The Contractor shall not operate construction equipment of any kind on or across public or private roadways having weights in excess of the maximum limit established by local authorities in charge of maintenance of such facilities unless expressed written permission is granted by such authorities. Each vehicle shall have a sufficient number of pneumatic tires to adequately maintain any vehicle wheel loading below the required limit. Except at authorized public crossings, the Contractor shall not cross roads unless otherwise permitted in writing by the appropriate local authority in charge of the affected facility. In addition to the requirements of this Article, the Contractor's attention is called to 1.12, Preservation of Property of these "General Conditions."

1.14 Responsibility for Repair of Facilities

- a. All existing NOR equipment or other facilities or other public or private facilities, including but not limited to existing canals, structures, telephone cables, roadways, parking lots, private drives, levees and embankments for canals, ponds and reservoirs disturbed by Contract construction shall be repaired and/or replaced to match existing. In addition, the Contractor shall be responsible for any settlement damage to such facilities or adjoining areas, for a period of one year after NOR acceptance of such required facilities. Regarding equipment furnished for Contractor's installation, Contractor shall obtain and bear the cost of any insurance which may be required with respect to meeting its obligations hereunder.

1.15 Traffic Control

- a. The maintaining of public vehicular traffic through the Work to adjacent driveways and intersecting streets shall conform and Contractor shall cooperate with local authorities relative to handling traffic through the area and shall make its own arrangements relative to maintaining uninterrupted access to all residences or businesses in the construction area at all times. Public vehicular traffic within and in the vicinity of project area, shall be permitted to pass through the Work area safely and with as little inconvenience as possible.

- b. Barricades and warning devices, to be provided by the Contractor, will be required to delineate the edge of traversable road, in such numbers necessary to maintain traffic safety and will conform to the style of the California State Division of Highways, "Traffic Manual," Chapter 5-10, of the "Work Area Traffic Control Handbook," or as directed by the Traffic Engineer.
- c. Barricades or fences shall be installed around all open-trenched areas at all times as required by the provisions of Cal OSHA requirements.
- d. Any flagmen needed shall follow the "Instructions of Flagmen" Figure 5-10, of the "Traffic Manual."
- e. All temporary traffic control signs will be provided and installed by the Contractor. "No Parking" signs shall be posted twenty-four (24) hours in advance of construction and shall state the hours and duration of the construction. It shall be the Contractor's responsibility to maintain said signs as posted during the duration of the project.
- f. All signs, barricades, warning devices, and flagmen's equipment shall be constructed of the correct materials and shall be of the correct color.
- g. Payment for the traffic control plan, detours, traffic control and accommodating public convenience for the entire length of this project shall be considered as included in the Contract, and no additional payment will be made therefore. No additional payment will be allowed for night and weekend work necessary to prepare and maintain traffic control and public convenience.

1.16 Public Convenience

- a. It is part of the service required by the Contractor to make whatever provisions are necessary to protect the public. The Contractor shall use foresight and shall take such steps and precautions as operations warrant to protect the public from danger, loss of life or loss of property, which would result from interruption or contamination of a public water supply, interruption of other public service, or from the failure of partly completed work or partially removed facilities. Unusual conditions may arise on the Work which will require that immediate and unusual provisions be made to protect the public from danger or loss, or damage to life and property, due directly or indirectly to prosecution of work under this Contract. Whenever, in the opinion of NOR, an emergency exists against which the Contractor has not taken sufficient precaution for the public safety, protection of utilities and protection of adjacent structures or property, which may be damaged by the Contractor's operations and when, in the opinion of NOR, immediate action shall be considered necessary in order to protect the public or property due to the Contractor's operations under this Contract, NOR will order the Contractor to provide a remedy for the unsafe condition. If the Contractor fails to act on the situation within a reasonable time period, NOR may provide suitable protection to said interests by causing such work to be done and material to be furnished which, in the opinion of NOR, is reasonable and necessary.
- b. The cost of said labor and material, together with the cost and expense of such repairs as deemed necessary, shall be borne by the Contractor. All expenses incurred by NOR for emergency repairs will be deducted from the progress payments and the final payments due to the Contractor. However, if NOR does not take such remedial measures, the Contractor is not relieved of the full responsibility for public safety.

SAFETY

1.17 Safety

- a. The Contractor is hereby informed that work on this Project could be hazardous. The Contractor shall carefully instruct all personnel working in potentially hazardous work areas regarding potential dangers and provide such necessary safety equipment and instructions as necessary to prevent injury to personnel and damage of property. Special care shall be exercised relative to work underground.
- b. The Contractor shall be solely and completely responsible for the conditions of the job site, including safety of all persons and property during performance of the Work. This requirement shall apply continuously and not be limited to normal working hours. Safety provisions shall conform to all applicable federal, state, county and local laws, ordinances, and codes, and to the rules and regulations established by the California Division of Industrial Safety, and to other rules of law applicable to the Work.
- c. In accordance with Section 6501 of the State Labor Code, the Contractor shall obtain a permit for all work subject to the requirements thereof. This in no way relieves the Contractor from the requirements of maintaining safety in all operations they or their Subcontractors perform.
- d. All equipment furnished shall be grounded and provided with guards and protection as required by safety codes. Where a vapor tight explosion proof electrical installation is required by code, it shall be provided. In accordance with the provisions of Sections 6705 and 6707 of the Labor Code, the Contractor shall retain the services of a registered civil or structural engineer, to design shoring if applicable. State and include this information in the proposal as a separate Bid Item. The Contractor shall submit these designs to NOR for review.
- e. Nothing in these Specifications shall be construed to permit work not conforming to governing codes. When Contract Documents differ from governing codes, the Contractor shall furnish and install the higher standards called for without extra charge.
- f. The duty of NOR or designated representative to conduct construction review of the Contractor's performance and the undertaking of inspection by NOR or the giving of instructions as authorized herein is not intended to include review of the adequacy of the Contractor's safety measures in, on, or near the construction site and shall not be construed as supervision of the actual construction nor make NOR responsible for providing a safe place for the performance of work by the Contractor, Subcontractors, or suppliers; or for access, visits, use, work, travel or occupancy by any person.

1.18 Accidents

- a. The Contractor shall provide, at the site, such equipment and medical facilities as necessary to supply first aid service to anyone who may be injured in connection with the Work.
- b. The Contractor shall promptly report in writing to NOR all accidents whatsoever arising out of, or in connection with the performance of the Work, whether on or adjacent to the site, which caused death, personal injury, or property damage, giving full details and statements of witnesses. In addition, if death or serious damage is caused, the accident shall be reported immediately by telephone or messenger to NOR.
- c. If any claim is made by anyone against the Contractor or any Subcontractor on account of an accident, the Contractor shall promptly report the facts in writing to NOR giving full details of the claim.

1.19 Fire Protection

- a. The Contractor shall not permit unauthorized fires either within or adjacent to the limits of the project and shall be liable for all damage from fire due directly or indirectly to construction activities, or actions of those of the Contractor's employees, or Subcontractors and their employees. The

Contractor shall conform to all federal, state or local laws and regulations pertaining to burning, fire prevention, and control within or adjacent to the Project. A copy of each required permit shall be furnished to NOR. The Contractor's forces or equipment may be required to fight fires in the vicinity, regardless of cause. NOR will not assume any responsibility of payment for fighting fire when such is ordered by Governmental Authority or when such is required for protection of the Work pursuant to the General Conditions.

1.20 Valley Fever – Notice to Employees

- a. A special biological problem of the project area is presence of tiny organisms living in the soil which can cause Valley Fever (coccidiomycosis) in man. As is typical of many desert areas in southwestern United States, Valley Fever is endemic to Kern County. Although everyone living in the valley has some contact with the disease causing organisms, the illness is a greater threat to those like construction employees whose work brings them into close contact with the soil. In accordance with the recommendation of the Kern County Health Department, the Contractor and all Subcontractors shall advise all their employees, in writing, to obtain coccidioidin skin tests before commencing work on this Project and at intervals thereafter as recommended by their family physician. The Contractor and all Subcontractors shall also advise all their employees, in writing, to wear dust masks while working under dusty conditions.

1.21 Coronavirus Disease 2019 - (COVID-19)

- a. Is a respiratory illness caused by a virus called SARS-CoV-2. Our understanding of how the virus spreads is evolving as we learn more about it, so check the CDC website for the latest information and current list of symptoms. The virus is thought to spread mainly from person to person:
 - (1) Between people who are in close contact with one another (within about 6 feet).
 - (2) Through respiratory droplets produced when an infected person coughs, sneezes, or talks.
- b. Recent studies indicate that the virus can be spread by people who are not showing symptoms. It may be possible that a person can get COVID-19 by touching a surface or object that has the virus on it and then touching their own mouth, nose, or possibly their eyes. This is not thought to be the main way the virus spreads, but we are still learning more about this virus. Older adults and people of any age who have serious underlying medical conditions may be at higher risk for severe illness from COVID-19.
- c. Potential sources of exposure include having close contact with a coworker or member of the public who is ill with COVID-19 and touching your nose, mouth, or eyes after touching surfaces contaminated with the virus or handling items that others infected with COVID-19 have touched. Actions you can take include the following:
 - (1) Notify your supervisor and stay home if you have symptoms.
 - (2) Follow CDC-recommended steps if you are sick. You should not return to work until the criteria to discontinue home isolation are met, in consultation with healthcare providers, your employer, and state and local health departments.
 - (3) Follow CDC-recommended precautions and notify your supervisor if you are well but have a sick family member at home with COVID-19.
 - (4) Limit close contact with others by maintaining a distance of at least 6 feet, when possible.
 - a. Limit the number of workers in small workspace areas such as job site elevators, trailers and vehicles, and spaces under construction if possible.

- (5) CDC recommends wearing cloth face coverings in public settings where other social distancing measures are difficult to maintain, especially in areas where there is significant community-based transmission of COVID-19.
 - a. Cloth face coverings may prevent people who don't know they have the virus from transmitting it to others.
 - (6) Cloth face coverings are NOT surgical masks or respirators and are not appropriate substitutes for them in workplaces where masks or respirators are recommended or required.
 - (7) Clean and disinfect frequently touched surfaces such as shared tools, machines, vehicles and other equipment, handrails, ladders, doorknobs, and portable toilets. Clean and disinfect frequently touched surfaces periodically throughout the shift but also:
 - a. At the beginning and end of every shift
 - b. After anyone uses your vehicle, tools, or workstation
 - (8) Limit tool sharing if possible.
 - (9) Practice proper hand hygiene. This is an important infection control measure. With appropriate hand hygiene, you do not need gloves to protect you from COVID-19. When possible, wash your hands regularly with soap and water for at least 20 seconds or use an alcohol-based hand sanitizer containing at least 60% alcohol. Key times to clean hands include:
 - a. Before and after work shifts and breaks
 - b. After blowing your nose, coughing, or sneezing
 - c. After using the restroom
 - d. Before eating and before and after preparing food
 - e. After touching objects which have been handled by coworkers, such as tools and equipment
 - f. Before putting on and after taking off work gloves
 - g. After putting on, touching, or removing cloth face coverings
 - h. Before donning or doffing eye or face protection (safety glasses, goggles, etc.)
 - (10) Do not touch your eyes, nose, or mouth.
 - (11) Use tissues when you cough, sneeze, or touch your face. Throw used tissues in the trash and wash your hands or use hand sanitizer containing 60% alcohol if a sink to wash your hands is not available.
- d. Employers should have a COVID-19 response plan to protect workers, following CDC Interim Guidance for Businesses and Employers, and share this plan with you and your coworkers in languages you all understand. Small construction businesses should review the CDC small business guidelines. Your employer should take steps to:

- (1) Reduce transmission among workers:
 - a. Take steps to help prevent the spread of COVID-19 if an employee is sick.
 1. Actively encourage sick employees to stay home.
 2. Sick employees diagnosed with COVID-19 shouldn't return to work until the criteria to discontinue home isolation are met, in consultation with healthcare providers and state and local health departments.
 - b. Provide employees with accurate information (in a language they understand) about COVID-19, how it spreads, and risk of exposure.
 1. Provide workers with basic facts.
 2. Conduct toolbox talks on all job sites to explain the protective measures in place.
 - c. Be aware that some employees may be at higher risk for severe illness, such as older adults and those with underlying medical conditions. Implement specific policies to minimize face-to-face contact for these employees or assign work tasks that allow them to maintain a distance of at least 6 feet from other workers, customers, and visitors, or to telework if possible.
 - d. Provide training to employees on proper handwashing practices and other routine preventative measures. This will help prevent the spread of many diseases, including COVID-19.
 - e. Provide employees with access to soap, clean running water, and materials for drying their hands, or if soap and water are not readily available provide alcohol-based hand sanitizers containing at least 60% alcohol at stations around the establishment for use by both workers and customers.
 - f. Place handwashing stations and/or hand sanitizers in multiple locations (including in or adjacent to portable restrooms) to encourage hand hygiene.
- (2) Explore alternative ways to promote hand hygiene if there is difficulty sourcing hand sanitizer and running water is not available on site. Some examples may include:
 - a. Install temporary or mobile handwashing stations, making sure there is an adequate supply of water, soap, and single-use paper towels.
 - b. Provide a large (5+ gallon) bucket with a lid and tap that can be used to provide water for handwashing. If this method is used, the water tap should be regularly cleaned and disinfected, and the contaminated wastewater must be collected and treated in accordance with local laws and environmental regulations. Provide fresh clean water daily.
 - c. Depending on the size or configuration of the job site, there may need to be multiple handwashing stations available to accommodate the workforce while maintaining social distancing, and stations may need to be restocked during the course of the day to maintain adequate handwashing supplies.
- (3) Develop and implement social distancing guidance for the workplace to maintain a distance of at least 6 feet between workers when possible.
- (4) Institute measures to physically separate and increase distance between employees, such as the following:

- a. Modify work schedules to stagger work, provide alternating workdays or extra shifts to reduce the total number of workers on a job site at any given time.
 - b. Restrict access to reduce the number of workers in enclosed and confined areas at one time. Confined and enclosed areas (e.g., trailers, small rooms in buildings under construction) should be identified and access should be restricted to essential personnel only. Enclosed spaces (e.g., toilets, break areas) are potential transmission areas and should be treated accordingly. Time spent in these areas should be minimized.
 - c. Rearrange administrative area workstations so that workers can stay at least 6 feet away from other workers.
 - d. Install shields or barriers, such as plexiglass barriers, where possible.
 - e. Remove or rearrange chairs and tables or add visual cue marks in break areas to support social distancing practices between workers. Identify alternative areas to accommodate overflow volume.
 - f. Disinfect break or lunchroom areas between each group using the areas.
 - g. Maintain social distancing when visiting lunch trucks or construction site vendors.
 - h. Limit casual (social) conversations that normally occur at work.
 - i. Cancel or postpone in-person meetings/trainings whenever possible. If you must meet, spread out to a distance of 6 feet or more between attendees.
 - j. Reduce the number of individuals at meetings, including worker orientations, to increase the distance between individuals.
- (5) Conduct a hazard assessment to determine if hazards are present, or are likely to be present, for which workers may need personal protective equipment (PPE). CDC and OSHA have recommended PPE for some types of work activities when engineering and administrative controls cannot be implemented or are not fully protective.
- a. Employers are required to determine, select, provide, and train on correct PPE use and application for their workers' specific job duties (see 29 CFR 1926 Subpart E).
- (6) Place posters that encourage staying home when sick, cough and sneeze etiquette, signs and symptoms of COVID-19, and proper hand hygiene practices at the entrance to the workplace and in other workplace areas where they are likely to be seen.
- (7) Provide tissues and no-touch disposal receptacles for employees to use.
- (8) Clean and disinfect frequently touched surfaces. If the surfaces are visibly dirty, clean them prior to disinfecting. To disinfect, use products that meet EPA's criteria for use against SARS-CoV-2 external icon, diluted household bleach solutions that are prepared according to the manufacturer's label for disinfection, or alcohol solutions with at least 70% alcohol, and that are appropriate for the surface. Follow manufacturer's directions for use.
- a. Clean workspaces and breakrooms at least once per shift or as often as workers change workstations.

- b. Provide worker training on manufacturer's directions for disinfectant use and provide workers with any additional PPE required for disinfection.
- (9) Provide disposable disinfectant wipes (when available) so that surfaces commonly touched can be wiped down.
- (10) Follow all applicable local, state, and federal regulations and public health agency guidelines.
- (11) Designate a safety and health officer to be responsible for responding to COVID-19 concerns at every jobsite. Workers should know who this person is and how to contact them.
- (12) Implement flexible sick leave and supportive policies and practices. Consider drafting non-punitive emergency sick leave policies if sick leave is not offered to some or all employees. Employers should not require a positive COVID-19 test result or a healthcare provider's note for employees who are sick to validate their illness, qualify for sick leave, or to return to work.
- (13) Provide information on whom to contact if employees become sick. If an employee is confirmed to have COVID-19 infection, employers should inform fellow employees of their possible exposure to COVID-19 in the workplace but maintain confidentiality as required by the Americans with Disabilities Act (ADA).
- e. Reach out to local public health officials to establish ongoing communications to facilitate access to relevant information before and during a local outbreak.

INSURANCE AND LIABILITY

1.22 Insurance

- a. The Contractor shall not commence any work until all required insurance is obtained at Contractor's expense. Such insurance must have the approval of NOR as to limit, form, and amount and shall be written by a company with an "AM Best A-VII" rating or higher. The Contractor shall not permit any Subcontractor to commence work on this project until the same insurance requirements have been complied with by such Subcontractor.
- b. Any insurance bearing on adequacy of performance shall be maintained after completion of the Project for the full guarantee period.
- c. The Contractor at Contractor's expense shall maintain in effect at all times during the performance of the Work under the Contract not less than the required coverage and limits of insurance, which shall be maintained with insurers and under forms of policy satisfactory to NOR which is specified in the Supplementary Conditions of the Contract.
- d. Promptly on execution of the Contract and prior to commencement of any work, the Contractor shall deliver to NOR certificates of insurance issued in triplicate (3) covering all policies providing the required insurance. Such certificates shall make reference to all such provisions and endorsements referred to above and shall be signed on behalf of the insurer by its authorized representative. The Contractor agrees to furnish one copy of each policy to NOR if requested in writing. Said copy shall be certified by an authorized representative of the insurer.
- e. All of the Contractor's policies shall contain an endorsement providing that written notice shall be given to NOR at least ten (10) calendar days prior to termination, cancellation, or reduction of coverage included in the policy.

- f. Any policy or policies of insurance that the Contractor elects to carry as insurance against loss or damage to his construction equipment and tools shall include a provision therein providing a waiver of the insurer's right to subrogation against NOR and its agents.
- g. The foregoing requirements as to the types, limits and NOR's approval of insurance coverage to be maintained by the Contractor are not intended to and shall not in any manner limit or qualify the liabilities and obligations assumed by the Contractor under this Contract.

1.23 Indemnity and Litigation Costs

- a. The Contractor is specifically obligated and hereby agrees to protect, hold free and harmless, defend and indemnify NOR and its consultants, and each of its officers, employees and agents from any and all liability, penalties, costs, losses, damages, expenses, causes of action, claims or judgements, including attorney's fees, which arise out of or are in any way connected with the Contractor's performance of work under this Contract whether attributable in whole or in part to the condition of the premises. To the extent legally permissible, this indemnity and hold harmless agreement by the Contractor shall apply to any acts or omissions, whether active or passive, on the part of the Contractor or agents, employees and representatives of the Contractor, or Subcontractors and Subcontractor's agents, employees and representatives resulting in liability irrespective of whether or not any acts or omissions of the parties to be indemnified hereunder may have also been a contributing factor to the liability.
- b. In the event that litigation of any nature between NOR and the Contractor becomes necessary to enforce or interpret all or any portion of this Contract, it is mutually agreed that the prevailing party therein shall receive from the other, in addition to such sums as may be reduced to judgement an amount sufficient to reimburse such prevailing party for reasonable attorney's fees and litigation costs paid or owing as a result of such litigation.
- c. No Personal Liability: Neither NOR, nor any other officer or authorized assistant or agent shall be personally responsible for any liability arising under the Contract, except such obligations as are specifically set fourth herein.

LABOR REQUIREMENTS

1.24 Labor Discrimination Prohibited

- a. Attention is directed to Sections 1735 and 1777.6 of the Labor Code, which read as follows:

Section 1735: "No discrimination shall be made in the employment of persons upon public works because of the race, religious creed, color, national origin, ancestry, physical handicap, medical condition, marital status, or sex of such persons, except as provided in Section 12940 of the Government Code, and every contractor for public works violating this section is subject to all the penalties imposed for a violation of this chapter."

Section 1777.6: "It shall be unlawful for any employer or a labor union to refuse to accept otherwise qualified employees as indentured apprentices on any public works, solely on the ground of the race, religious creed, color, national origin, ancestry, or sex of such employee."

b. Contractor shall cause clauses identical to the above-cited prohibitions to be included in every subcontract for the Project Work and Contractor hereby stipulates that such conditions shall be required of its Subcontractors.

1.25 Mandatory Certification of Contractor and Employment of Apprentices

- a. This Contract shall not prevent the employment of properly indentured apprentices in accordance with the California Labor Code, and no employer or labor union shall refuse to accept otherwise qualified employees as indentured apprentices on the Work performed hereunder solely on the grounds of race, creed, national origin, ancestry, color, or sex. Every qualified apprentice shall be paid the standard wage paid to apprentices under the regulations of the craft or trade in which he/she is employed, and shall be employed only in the craft or trade to which he/she is indentured.
- b. If California Labor Code Section 1777.5 applies to the Contract Work, the Contractor and any Subcontractor hereunder who employ workers in any apprenticeable craft or trade shall apply to the joint apprenticeship council administering applicable standards for a certificate approving the Contractor or Subcontractor for the employment and training of apprentices. Upon issuance of this certificate, the Contractor and any Subcontractor shall employ the number of apprentices provided for therein, as well as contribute to the fund to administer the apprenticeship program in each craft or trade in the area of the work hereunder.
- c. The parties expressly understand that the responsibility for compliance with this section and with Sections 1777.5, 1776.5 and 1777.7 of the California Labor Code, in regard to all apprenticeable occupations, lies with the Contractor hereunder.
- d. In accordance with Labor Code Section 1773.3, NOR will send notice of the award of this Contract to the Division of Apprenticeship Standards within five days after award if the Contract is awarded to a general contractor in the amount of at least \$30,000 and involves at least 20 working days, or is awarded to a specialty contractor in the amount of \$2,000 and involves at least five working days, if such general or specialty contractor employs workers in an apprenticeable craft or trade.

1.26 Prevailing Rates of Wages and Payroll Records

- a. As suggested in the Notice Inviting Bids, NOR has obtained from the Director of the Department of Industrial Relations the general prevailing rate of per diem wages and the general prevailing rate for holiday and overtime work in the locality in which the Contract Work is to be performed for each craft, classification, or type of worker needed to execute the Contract, a copy of which is hereby incorporated by reference. The prevailing rates of per diem wages are available at the California Department of Industrial Relations website (www.dir.ca.gov/dlsr/pwd/index.htm).
- b. Contractor shall forfeit to NOR, as a penalty, \$50.00 for each calendar day, or portion thereof, for each worker paid less than the said per diem wage for any work done under the Contract by it or by any Subcontractor under it in violation of the provisions of the California Labor Code. It is hereby stipulated by and between NOR and Contractor that Contractor will comply with provisions of California Labor Code Section 1775. The term "per diem wages" shall be deemed to include travel and subsistence payments, which are required by California Labor Code Section 1773.8 to be paid to each worker performing work under the Contract.
- c. Contractor shall keep an accurate payroll record, showing the name, address, social security number, work classification, straight time and overtime hours worked each day and week, and the actual per diem wages paid to each journeyman, apprentice or worker employed. Such records shall be available for inspection at all reasonable hours and a copy shall be made available to any employee or employee's authorized representative, the Division of Labor Standards Enforcement, and the Division of Apprenticeship Standards in compliance with California Labor Code Section 1776. Upon written notice from NOR or the Division of Labor Standards Enforcement, Contractor shall within ten days file with NOR a certified copy of the payroll records. Contractor shall cause an identical clause to be included in every subcontract for Contract work.

1.27 Eight-Hour Day Limitation

- a. Eight (8) hours constitutes a legal day's work (Labor Code, Section 1810). The time or service of any workman employed on this project is limited and restricted to eight (8) hours during any one calendar day, and 40 hours during any one calendar week, except as provided for under Section 1815 of the Labor Code (Labor Code, Section 1811).
- b. Every Contractor and Subcontractor shall keep an accurate record showing the names and actual hours worked each calendar day and each calendar week by each workman employed in connection with the public work. The record shall be kept open at all reasonable hours to the inspection of NOR and to the Division of Labor Law Enforcement (Labor Code, Section 1812).
- c. The Contractor shall, as a penalty to NOR, forfeit twenty-five dollars (\$25) for each workman employed in the execution of the Contract by the Contractor or by any Subcontractor for each calendar day during which such workman is required or permitted to work more than eight (8) hours in any one calendar day and forty (40) hours in any one calendar week in violation of the provisions of this article (Labor Code, Section 1813). Any Contractor or Subcontractor who neglects to comply with any provision of Section 1812 is guilty of a misdemeanor (Labor Code, Section 1814).
- d. Work performed by employees of Contractors in excess of eight (8) hours per day, and forty (40) hours during any one week, shall be permitted for public work upon compensation for all hours worked in excess of eight (8) hours per day at not less than one and one-half (1½) times the basic rate of pay (Labor Code, Section 1815).

1.28 Worker Benefits

- a. In accordance with Section 1773.1 of the Labor Code, per diem wages shall be deemed to include employer payments for health and welfare, pension, vacation, travel time, and subsistence pay as provided in Section 1773.7, apprenticeship or other training programs authorized by Section 3093, and similar purposes.
- b. In accordance with Section 1773.8 of the Labor Code, the Contractor and Subcontractor must provide travel and subsistence payments to each workman needed to execute the Work, as such travel and subsistence payments are defined in the applicable collective bargaining agreements filed in accordance with this section.

MATERIALS AND EQUIPMENT

1.29 Materials Furnished by the Contractor

- a. General: Unless otherwise specified, the Contractor shall furnish all materials necessary for the execution and completion of the work. All materials, unless otherwise specified, shall be new, and shall be manufactured, handled and installed in a workmanlike manner to insure completion of work in accordance with the Contract Documents. The Contractor shall, if required, furnish satisfactory evidence as to the kind and quality of materials, including furnishing written manufacturer's certifications of compliance with applicable designated governing reference specifications.
- b. Materials Furnished NOR: Where materials are to be furnished by NOR, the type, size, quantity and location at which they are available will be stated in the Supplementary Conditions.

1.30 Records of Materials Purchased

- a. If required by NOR, the Contractor shall furnish duplicate invoices to NOR on all Materials furnished to the project.

1.31 Material Storage and Protection

- a. During the progress of the Work, products and materials shall be neatly stored in accordance with the appropriate manufacturer's recommendations and shall be properly cared for and protected from weather, vandalism, and theft.
- b. All installed products and materials shall be adequately protected until such time that NOR accepts the Project.

1.32 Right to Operate Unsatisfactory Equipment or Facilities

- a. If, following installation of any equipment or facilities furnished by the Contractor, defects requiring correction by the Contract are found, NOR shall have the right to operate such unsatisfactory equipment or facilities and make reasonable use thereof until the equipment can be shut down for correction of defects without injury to NOR.

1.33 Warranty

- a. The Contractor shall guarantee all materials, workmanship and equipment furnished under these specifications for a period of at least one (1) year from the date of filing the Notice of Completion. Should certain projects or contracts require longer warranty periods, those specified warranty periods shall then supersede the normal one year warranty period. Such other warranty periods will require specific warranty statements required in the contract package. Upon receipt of written notice from NOR of the failure of any part during the guarantee period, due to defective materials furnished, workmanship or equipment furnished, the affected part, or any other work or property damaged on account thereof, shall be repaired or replaced to the satisfaction of NOR by and at the expense of the Contractor.
- b. Should the Contractor fail to act immediately in making the necessary repairs and replacements, NOR may perform or cause to be performed the necessary replacement and the Contractor shall pay to NOR the actual cost of such replacement. The Contractor and its Sureties shall be responsible for the full expense incidental to satisfying the guarantee.
- c. Nothing in this section shall be construed to limit, relieve or release the Contractor's liability to NOR for damages sustained as the result of latent defects in the equipment furnished caused by the negligence of the Contractor's agents, employees or Subcontractors. Stated in another manner, the warranty contained in this section shall not amount to nor shall it be deemed to be a waiver by NOR of any rights or remedies (or time limits in which to enforce such rights or remedies) it may have against the Contractor of the equipment to be furnished under these Specifications for defective workmanship or defective materials under the laws of this State pertaining to acts of negligence.

1.34 Trade Names or Approved Equals

- a. Where shown on the Drawings, or where specified, certain equipment, materials or other items are designated for procurement by a trade name, or the name of a manufacturer and the manufacturer's catalog information or approved equal. The use of alternate items of equal quality will be allowed only when approved and authorized in writing by NOR. The burden of proof as to comparative quality and suitability of proposed alternates to NOR design applications shall be upon the Contractor who shall furnish, at no expense to NOR, all necessary information required by NOR to make a judgement that the proposal is "equal". Where a given design application utilizing a trade name product is considered to be unique or novel, no alternate item of equipment will be allowed. NOR will be the sole judge as to the acceptability of proposed alternates and this decision shall be final.

- b. "Or Equal": Where the phrase "or equal" or "or equal as approved by NOR" occurs in the Contract Documents, do not assume that the materials, equipment, or methods will be approved as equal unless the item has been specifically so approved for this work by NOR prior to submittal of a bid.
- c. Substitutions will be considered and may be approved if they meet appropriate standards and conditions described herein.
 - (1) Reference in the Contract Documents to any material, product, or process by name, make, or catalog number shall be interpreted as establishing a standard of quality and design intent and not construed as prohibiting substitutions of any other such material, product, or process, provided such substitution is acceptable and fulfills the design intent of the Work and is accepted through the judgement of the Engineer.
 - (2) Acceptance of substitutions will not relieve the Contractor from responsibility for complying with the requirements of the Contract Documents.
 - (3) At the discretion of the Engineer, testing of material samples proposed for substitutions may be required. The testing shall be done by an independent testing laboratory selected by NOR, the costs for which shall be borne by NOR. Costs for retesting failed items shall be paid by the Contractor.
 - (4) At the discretion of the Engineer, the Contractor may be required to furnish a written guarantee, in addition to that already required, insuring the satisfactory performance of the proposed substitute.
 - (5) All additional labor and materials which may be required for the proper installation of any substitution, or required as a consequence of any substitution, shall be provided at no additional cost to NOR.
 - (6) Bids shall be based upon the data given in these Contract Documents, or upon previously approved items or techniques designated as "approved equals" by NOR. Where calculations or shop drawings are required for approval, allowance shall be made for meeting the requirements of the Contract Documents and all applicable codes and ordinances.
 - (7) Bidders may, in addition, submit separate bids using materials and equipment of other manufacturers, providing the difference in cost is stated for each item proposed to be substituted.
 - (8) Provide to NOR all information necessary and required to evaluate proposed substitutions. Do not base bid on the assumption that a material will be approved as equal by NOR unless the item has been specifically approved for this Work by NOR prior to receipt of bids.

1.35 Submittals

- a. To ensure that the desired products are furnished and installed in accordance with design intent, certain procedures are established for the advance submittal of design data and its approval or rejection by NOR. See Division 1, Section 01300, for specific requirements.

1.36 Requirements Described Elsewhere

- a. Listing of submittals required for the various portions of the Work are included in the Sections of these Specifications pertaining to the Work involved and occasionally in the Drawings for miscellaneous items of equipment, materials or procedures.

1.37 Schedule of Submittals

- a. Compile a complete schedule of submittals according to the provisions of Division 1, Section 01300 Submittals and Substitutions. Submit such a schedule to NOR for comment and approval. The approved Schedule of Submittals shall be kept current at all times and an updated copy shall be kept at the job for review. All submittals shall be furnished within thirty-five (35) calendar days after the award of contract. Within fourteen (14) calendar days NOR will return appropriately marked copy(ies).

1.38 Samples

- a. Unless otherwise specifically directed by NOR, all samples shall be of the precise article proposed to be furnished.
- b. Submit all samples in the quantity which is required to be returned, plus one (1) which will be retained by NOR.

1.39 Colors

- a. Unless the precise colors and patterns are specifically described in the Contract Documents, whenever a choice of color or pattern is available for a specified product submit accurate color charts to NOR for review and selection.

1.40 Shop and Fabrication Drawings

- a. General: Drawings furnished by NOR shall not be construed as shop or fabrication drawings. The Contractor shall furnish to NOR four (4) copies of all shop and fabrication drawings which are required prior to the fabrication or placement of any or all items. With each shop drawings submittal, an accompanying letter of transmittal shall be provided. Shop drawings for equipment shall show all installation dimensions and details. All shop drawings must bear the stamp of approval of the Contractor showing evidence that it has checked and approved the drawings. Any drawings submitted without said stamp of approval will not be considered and will be returned to the Contractor for proper resubmission. If the shop drawings show variances from the requirements of the Contract because of standard shop practice or other reasons, the Contractor shall make specific mention of such variation(s), including reasons therefore. This explanation shall be provided in the accompanying letter of transmittal in order that, if acceptable, suitable action may be taken; otherwise, the Contractor will not be relieved of the responsibility for executing the work in accordance with the Contract Specifications and Drawings. NOR will not review shop drawings until all details are properly provided.
- b. Time for Submission and Review: Shop and fabrication drawings for all items of work to be furnished and installed under this Contract shall be submitted within thirty-five (35) calendar days of the date of the award of Contract for the Work. Within fourteen (14) calendar days after receipt of shop or fabrication drawings, NOR will return one copy of these drawings to the Contractor marked as appropriate. The Contractor shall then revise the shop or fabrication drawings as requested by NOR or submit an alternate to the revision and perform the Work in accordance with the revision or approved alternate therefore. The Contractor shall furnish NOR one transparency plus a blue-line copy of the reviewed and revised shop and fabrication drawings immediately upon furnishing the requested revisions or entering the approved alternate on the shop drawings and prior to delivery or installation of any materials shown thereon.
- c. Effect of NOR's Review: NOR reserves the right to require, at no additional cost over the prices stated in the Bidding Schedule, such modifications or alterations as deemed necessary by NOR to make the equipment conform to the provisions and intent of the Contract. Notwithstanding the above provisions, the Contractor shall be responsible for obtaining proper fit and dimensions, and adequate

strength to withstand specified dynamic and static loadings on materials and equipment being furnished; NOR's review will apply only to the general arrangement of the materials or equipment. Fabrication or other work done prior to the Contractor's receipt of the reviewed shop and fabrication drawings will be done entirely at the Contractor's risk. Review of the Contractor's drawings by NOR shall not be held to relieve the Contractor of any obligations to meet all the requirements of the Contract or relieve the Contractor of the responsibility for the correctness of such drawings. The Contractor shall, at no expense to NOR, make any changes in the design which are necessary to make the equipment conform to the provisions and intent of the Contract.

- d. Line-Out Drawings for Pipework: Prior to fabrication of any pipe materials described in the Specifications, the Contractor shall submit line layout drawings and shop drawings showing all pertinent details for field installation and shop fabrication of pipe, pipefittings and special requirements for pipelines, including joint details for approval by NOR. Line layout drawings shall indicate, at a minimum, pipe class, type, location and dimensions of fittings and special requirements. Pipe, pipefittings, special applications and joints therefore either shall be fabricated in accordance with the Specification Drawings or in accordance with the Contractor's shop drawings, at the option of NOR. Delay in submittal of either line layout drawings for field installation work or delay in submittal of shop drawings will be cause for NOR to retain liquidated damages.

1.41 Record Drawings

- a. The Contractor shall continuously maintain required as-built drawings as the job progresses. A separate set of prints, for this purpose only, shall be kept at the job site. It shall be required that these drawings be up to date and so certified at the conclusion of all underground work and at the completion of major phases of the work. Progress payments may be held if appropriate as-builts are not current.
- b. Upon completion of the Work, submit neatly prepared reproducible drawings showing all changes to the Work. Drawings shall be stamped "AS-BUILT" with a signature, printed name and date the drawings were certified to be correct. Deliver the corrected and completed "as-built" drawings to NOR. Delivery of the drawings will not relieve the Contractor of the responsibility of furnishing further required information should discrepancies be found between site conditions and drawings.
- c. The following work shall be included in the "as-builts" records: Underground utilities and layout including sewer, gas, water, electric, telephone, cable TV, etc., plumbing, heating, ventilating, air conditioning, irrigation and other systems as may be specifically requested. All as-built work shall be properly dimensioned on the plans to assure accurate location.
- d. Final payment will not be made without submittal to NOR of complete as-builts for all work described.

1.42 Manuals

- a. Where manuals are required to be submitted upon completion of the installation, prepare all such manuals in durable binders approximately 8½" x 11" in size and with at least the following features:
 - (1) Identification readable on the outside of the cover listing project title and stating general nature of the manual and the project to which it pertains.
 - (2) Tab index reference to all sections of the manual. Tabs shall be neatly identified with typed or clearly hand lettered headings.
 - (3) Complete instructions regarding operation and maintenance of all equipment shall be included.

- (4) A listing of replaceable parts, including part numbers, as provided on product specification sheets. Identify suppliers and their addresses and phone numbers.
 - (5) Copies of all guarantees and warranties issued for project products.
 - (6) Copies of the approved shop drawings with all data concerning changes made during construction.
- b. Where contents of manuals include manufacturer's catalog pages, clearly indicate the precise items included in this installation and delete, or otherwise clearly indicate, all manufacturer's data with which this installation is not concerned. Provide names, addresses and phone numbers of local manufacturer's representatives and manufacturer's corporate offices.
 - c. All manuals shall be submitted and judged complete and satisfactory by NOR prior to release of the project final payment.

PROGRESS AND COMPLETION – TERMINATION

1.43 Progress and Completion of Work

- a. General: Unless otherwise directed by NOR, the Contractor shall begin work within ten (10) calendar days after the date of the Notice to Proceed. All work to be performed under this Contract shall be completed within the time specified in the Supplementary Conditions beginning with the Notice to Proceed date.

1.44 Progress Schedule and Order of Completion

- a. To insure completion of the Work within the time specified and to assist NOR in the scheduling of other work, the Contractor shall submit to NOR within seven (7) calendar days after receiving the Notice to Proceed a detailed schedule showing the proposed dates of beginning and completion of all significant items of work under the Contract. If the actual progress of the work varies materially from the proposed program, or the Contractor proposes to change the program for any reason, the revised construction program shall be submitted to NOR. The proposed original and revised program shall be adequate, in the opinion of NOR, to meet the requirements for completion of the Work as herein set forth. If, in the opinion of NOR, the Contractor's proposed program or the actual progress of the Work is insufficient to meet the specified requirements, Contractor shall take such steps as necessary to accomplish the required progress and completion.
- b. When in the judgement of NOR it is necessary to accelerate any part of the Work ahead of schedule, the Contractor shall, when directed, concentrate his efforts on such part of the Work.

1.45 Contractor's Forces, Equipment and Progress

- a. The capacity of the Contractor's construction plant, sequence of operations, methods of operation, and the forces employed shall at all times during the continuance of the Contract be subject to approval of NOR and shall be such as to insure the completion of the work within the specified period of time. The Contractor shall furnish sufficient forces, construction plant and equipment, and shall work such hours, including extra shifts and overtime operations, and shall furnish such other necessities so as to assure the prosecution of work in accordance with the Specifications and the time requirements specified herein.

1.46 Failure to Complete the Work in the Time Agreed Upon

- a. Liquidated Damages: It is agreed by the parties to the Contract that time is of the essence; and that in case all the work is not completed before or upon the expiration of the time as set forth, or within any time extensions that may be granted, damage will be sustained by NOR, and that it may be impracticable to determine the actual amount of damage by reason of such delay; and it is, therefore, agreed that the Contractor will pay to NOR as damages the amount per day as indicated in the Supplementary Conditions section of these Specifications.
- b. In addition, NOR shall have the right to charge to the Contractor and to deduct from the final payment for the Work, the actual cost to NOR for engineering, inspection superintendence, and other overhead expenses which are directly chargeable to the Contract and which accrue during the period of such delay except that the cost of final inspection and preparation of the final estimate shall not be included in such charges. The expenses and damages described above shall be deducted from any money due to the Contractor under this Contract, and the Contractor and responsible sureties shall be liable for any such excess cost, and expense shall be mutually agreed to as damages suffered by NOR on account of the failure of the Contractor to complete the Work within the time limit of the Contract.

1.47 Use of Completed Portions, Right to Operate Facilities

- a. NOR, at any time, and from time to time, during the performance of the Work, may enter the Work for the purpose of installing any necessary work NOR labor or other contracts, and for any other purpose in connection with the installation of facilities.
- b. If, prior to completion and final acceptance of all the Work, NOR takes possession of any structure or work (whether completed or otherwise) comprising a portion of the Work with the intent of retaining possession thereof (as distinguished from temporary possession contemplating the return to the Contract), then, while NOR is in possession of the same, the Contractor shall be relieved of liability for loss and damage to structure other than that resulting from the Contractor's fault or negligence. Such taking of possession by NOR shall not relieve the Contractor from any provisions of this Contract respecting such structure, other than to the extent specified in the preceding sentence, nor constitute a final acceptance of such structure.
- c. The Contractor shall make available, in the areas occupied, any utility, heating and cooling as are in condition to be put in operation at the time of early occupancy. All responsibility for said equipment shall remain with the Contractor while it is so operated. However, an itemized list of each piece of equipment so operated with the date operation commences shall be made and certified by NOR. This list shall be the basis for the commencement of guarantee of NOR's early occupancy. NOR shall pay for all utility costs which arise out of the occupancy by NOR during construction.

1.48 Time of Work – Termination for Delay – Time Extensions

- a. The Contractor shall at all times employ such force, plant materials and tools as will be sufficient, in the opinion of NOR, to prosecute the work at not less than the rates fixed under the terms of the Contract and to complete the Work or any separable portion thereof within the time limits fixed therein. If the Contractor refuses or fails to prosecute the Work or any separable part thereof, with such diligence as will insure the completion within the time specified in the Contract, or any extension thereof, or fails to complete said Work within such time, NOR may by written notice to the Contractor terminate his right to proceed with the Work or such part of the Work which has been delayed. In such event, NOR may take over the Work and prosecute the same to completion by contract or otherwise, and may take possession of and utilize in completing the work such materials, appliances, equipment and plants as may be on the site of the Work and necessary therefore. Whether or not the Contractor's right to proceed with the Work is terminated, it and its sureties shall be liable for all damages, including attorney's fees, sustained or incurred by NOR by reason of such default and in enforcing the provisions hereof against the Contractor.

- b. On award of the Contract it is the responsibility of the Contractor to properly and promptly order materials and equipment required for the Work. If evidence presented demonstrates that, in spite of the Contractor's efforts, government-established priority controls delay material deliveries, suitable extension of time will be made.
- c. The Contractor's right to proceed shall not be so terminated nor the Contractor charged with resulting damage if:
 - (1) The delay in the completion of the Work arises from unforeseeable causes beyond the control and without the fault or negligence of the Contractor, including but not restricted to acts of God, acts of the public enemy, acts of NOR in either its governmental or contractual capacity, acts of another contractor in the performance of a contract with NOR, fires, floods (excluding site flooding due to groundwater), epidemics, quarantine restrictions, strikes, lockouts, freight embargoes, unusually severe weather, or delays of subcontractors and suppliers arising from unforeseeable causes beyond the control and without fault or negligence of either the Contractor or such subcontractors and suppliers.
 - (2) The delay caused the Contractor by specific order of NOR to stop work or by the performance of extra work ordered by NOR or by failure of NOR to provide the necessary site for installation or by unforeseen causes beyond the control of the Contractor such delay will entitle the Contractor to an equivalent extension of time, except as otherwise provided.
 - (3) The Contractor within ten (10) days from the beginning of any such delay (unless NOR grants further period of time before the date of final payment under the Contract) notifies NOR in writing of the causes of delay and requests an extension of time.
- d. NOR shall ascertain the facts and the extent of the delay and extend the time for completing the Work when, in its judgement, the findings of fact justifies such an extension, and findings of fact shall be final and conclusive on the parties.
- e. The rights and remedies of NOR provided in this clause are in addition to any of the rights and remedies provided by law or under this Contract.
- f. A request for an extension of time, or the granting of an extension of time shall not constitute a basis for any claim against NOR for additional compensation. The Contractor shall be deemed to have waived any claim for additional compensation and does hereby so waive any such claim.

1.49 Termination for Reasons Other Than Delivery

- a. If the Contractor should be adjudged bankrupt, or if he should make a general assignment for the benefit of his creditors, or if a receiver should be appointed for the Contractor on account of his insolvency and when not discharged within ten (10) days after his appointment, or if he should persistently or repeatedly refuse or fail, except in cases for which extension of time is provided, to supply enough properly skilled workmen or proper materials to diligently pursue the Work, or if he should fail to make prompt payment to Subcontractors or for material or labor, or if he should persistently disregard laws, ordinances, or instructions of NOR, or otherwise be guilty of a substantial violation of any provision of the Contract, then NOR, may without prejudice to any right or remedy, and after giving the Contractor ten (10) days written notice, terminate the employment of the Contractor and take possession of the premises and of all equipment, materials, tools, and other facilities thereon and finish the Work by whatever method NOR may deem expedient. In such case, the Contractor shall not be entitled to receive any further payment until the Work is finished. If upon completion of the Work the total cost to NOR, including attorney's fees, in connection therewith shall be less than the amount which would have been paid if the Work had been completed by the

Contractor in accordance with the terms of the Contract, then said difference shall be paid to the Contractor in the same manner as the final payment under the Contract. If the expense, including the attorney's fees, incurred by NOR on account of termination of employment of the Contractor and subsequent completion of the Work by NOR by whatever method NOR may deem expedient shall exceed said amount which the Contractor would otherwise have been paid, the Contractor and its sureties shall be liable to NOR for the full amount of such excess expense.

- b. In addition to its rights under subparagraph (a) hereof, if at any time before completion of the Work under the Contract it shall be determined by NOR that reasons beyond the control of the parties will not allow completion of the Work, or if the Work shall be stopped by an injunction of a court of competent jurisdiction or by order of any competent authority, NOR may, upon ten (10) days written notice to the Contractor, discontinue the Work and terminate the Contract. Upon service of such notice of termination, the Contractor shall discontinue the Work in such manner, sequence, and at such times as NOR may direct. The Contractor shall have no claim for damages for such discontinuance or termination, nor any claim for anticipated profits on the Work thus dispensed with, nor any other claim except for the Work actually performed up to the time of complete discontinuance including any Extra Work ordered by NOR to be done, for any liquidated damages due hereunder in accordance with the provisions relating to Suspension of Work.

QUALITY CONTROL OF THE WORK

1.50 Assignment

- a. Neither party to the Contract shall assign the Contract or sublet it as a whole or in part without the written consent of the other, nor shall the Contractor assign any monies due, or to become due to him hereafter, without the previous written consent of NOR.

1.51 Superintendence – Personal Attention

- a. The Contractor shall designate, in writing, before starting work, an authorized representative who shall have complete authority to represent and to act for the Contractor. Said authorized representative shall be present at the site of the Work at all times while Contract Work is actually in progress.
- b. During periods when work is suspended, arrangements acceptable to NOR shall be made for any emergency work which may be required.
- c. Information shall include the representative's name, street address, town and telephone number, and the mailing address if different from the street address.

1.52 Legal Address of Contractor

- a. The address given in the Contractor's Proposal on which the Contract is founded is hereby designated as the place to which all notices, letters and other communications to the Contractor shall be mailed or delivered. The delivering at the above-named place or the depositing in a postpaid wrapper directed to the above place, in any post office mailbox, regularly maintained by the United States Post Office, of any notice, letter or other communication to the Contractor and the date of said service shall be the date of such delivery or mailing. Such address may be changed at any time by written notice signed by the Contractor and delivered to NOR.
- b. Nothing herein contained shall be deemed to preclude or render in-operative the service, letter or other communication served upon the Contractor personally.

1.53 Authority of NOR

- a. NOR has full authority to interpret the Contract Documents, to conduct the construction review and inspection of the Contractor's performance, and to decide questions which arise during the course of the Work, and its decisions on these matters shall be final and binding. NOR has the authority to reject all work and materials which do not conform to the Contract Documents.
- b. If at any time the Contractor's work force, tools, plants or equipment appear to NOR to be insufficient or inappropriate to secure the required quality of work or the proper rate of progress, NOR may order the Contractor to increase their efficiency, improve their character to augment their number or to substitute other personnel, new tools, plants or equipment, as the case may be, and the Contractor shall comply with such order.
- c. NOR shall have the authority to make minor changes in the Work, not involving extra costs, and not inconsistent with the purposes of the Work.
- d. Any order given by NOR, not otherwise required by the Contract Documents shall, on request of the Contractor, be given or confirmed by NOR in writing.
- e. Whenever work, methods of procedure, or any other matters are made subject to direction or approval, such direction or approval will be given by NOR.

1.54 Inspection of Work

- a. Unless otherwise provided, all equipment, materials, and work shall be subject to inspection and testing by NOR and either Kern County or the City of Bakersfield who permit the Work. NOR will observe the progress and quality of the Work and determine, in general, if the Work is proceeding in accordance with the intent of the Contract Documents. NOR shall not be required to make comprehensive or continuous inspections to check quality of the Work and shall not be responsible for construction means, methods, techniques, sequences, or procedures or for safety precautions and programs in connection with the Work. Visits and observations made by NOR shall not relieve the Contractor of the obligation to conduct comprehensive inspections of the Work and to furnish proper materials and perform acceptable Work, and to provide adequate safety precautions, in conformance with the intent of the Contract.
- b. Whenever the Contractor varies the period during which work is carried on each day, notice shall be given to NOR so that proper inspection may be provided. Any work done in the absence of NOR shall be subject to rejection. Proper facilities for safe access to inspect all parts of the Work, shall at times be maintained for the necessary use of the agency, and agents of the State, NOR, City or County at all reasonable hours for inspection by such agencies to ascertain compliance with laws and regulations.
- c. One or more inspectors may be assigned to observe the Work and to act in matters of construction under this Contract. It is understood that such inspector shall have the power to issue instructions and make decisions within the limitations of the authority of NOR. Such inspection shall not relieve the Contractor of its obligation to conduct comprehensive inspections of the Work and to furnish proper materials and perform acceptable work, and to provide adequate safety precautions in conformance with the intent of the Contract.
- d. NOR and its representatives shall at all times have access to the Work whether it is in preparation or progress, and the Contractor shall provide safe and convenient facilities for such access and for inspection. If the Specifications, NOR's instructions, laws, ordinances, or any public authority require any material, equipment or work to be specially tested or approved, the Contractor shall give NOR timely notice of its readiness for inspection, and if the inspection is by an authority other than NOR, of the time fixed for inspection. Inspections by NOR will be made promptly and where practicable at the source of supply.

- e. Work performed without inspection may be required to be removed and replaced under proper inspection and the entire cost of removal, replacing, including the cost of NOR furnished materials used in the Work, shall be borne by the Contractor, regardless of whether or not the Work exposed is found to be defective. Examination of questioned work that is installed without inspection, may be ordered by NOR and, if so ordered, the work must be uncovered by the Contractor. All costs to examine and inspect this work, including testing, shall be paid by the Contractor.
- f. Inspection of the Work shall not relieve the Contractor's obligation to fulfill the Contract as herein prescribed or in any way alter the standard of performance provided by the Contractor, and defective work shall be made good, and unusual materials may be rejected, notwithstanding that such work and materials have been previously overlooked by NOR and accepted or estimated for payment. If the Work or any part thereof shall be found defective the Contractor shall within ten (10) calendar days make good such defect in a manner satisfactory to NOR. If the Contractor shall fail or neglect to make ordered repairs of defective work to remove the condemned materials from the Work within ten (10) calendar days after direction in writing by NOR, NOR may make the ordered repairs or remove the condemned materials, and deduct the cost thereof from any monies due to the Contractor.
- g. The Contractor shall furnish promptly without additional charge, all facilities, labor and materials reasonably needed by NOR for performing all inspections and tests. The Contractor shall be charged with any additional cost of inspection when material and workmanship are not ready at the time specified by the Contractor for its inspection.
- h. Except as specifically required under the materials specifications, all tests of materials furnished by the Contractor shall be made by NOR in accordance with commonly recognized standards of national organizations. The Contractor shall furnish such samples of materials as required by NOR without charge. No material shall be used unless it has received favorable review by NOR.
- i. Where such inspection and testing are to be conducted by an independent laboratory the sample or samples of materials to be tested shall be selected by such laboratory or NOR and not by the Contractor.
- j. The cost of special inspection and tests of materials made by or at the request of NOR, in addition to those required herein, shall be borne by NOR, except for the costs of retesting rejected materials which shall be borne by the Contractor.
- k. Where any part of the Work is being done under an encroachment permit or building permit, or is subject to Federal, State (including any agency created by interstate contract), County or Municipal codes, laws, ordinances, rules or regulations, representatives of the governing agency shall have full access to the Work and shall be allowed to make any inspection or test in accordance with such permits, codes, laws, ordinances, rules or regulations. If advance notice of the readiness of the Work for inspection by the governing agency is required, the Contractor shall furnish such notice to the appropriate agency.

1.55 Compliance with Laws – Permits, Regulations, Taxes

- a. The Contractor shall be aware and ensure the Subcontractors are fully informed of all applicable State and National laws, County and Municipal ordinances and regulations which in any manner affect those engaged or employed in the Work, or the materials and equipment used in the Work, or which in any way affect the conduct of the Work and of all such orders and decrees of bodies or tribunals having any jurisdiction or authority over the same.

- b. Nothing in the Contract Documents is to be construed to permit work not conforming to governing codes. When Contract Documents differ from governing codes, the Contractor shall furnish and install the higher standards called for without extra charge. If any discrepancy or inconsistency is discovered in the Drawings or Specifications, or in this Contract in relation to any such law, ordinance, regulation, order of decree, the Contractor shall forthwith report the same to NOR in writing. The Contractor shall at all times observe and comply with all such applicable laws, ordinances, regulations, orders, and decrees; and shall protect and indemnify NOR and all of NOR's officers, agents and servants against any claim or liability arising from or based upon the violation of any such law, ordinance, regulation, order or decree, whether by the Contractor or by the Contractor's employees. Particular attention is called to the following.
- (1) Contractor is an independent Contractor and shall, at its sole cost and expense, comply with all laws, rules, ordinances and regulations of all governing bodies having jurisdiction over the Work, obtain all necessary permits and licenses therefore, pay all manufacturers taxes, sales taxes, use taxes, processing taxes, and all federal and state taxes, insurance and contributions for social security and unemployment which are measured by wages, salaries or any remuneration paid to Contractor's employees, whether levied under existing or subsequently enacted laws, rules or regulations. Contractor shall also pay all property tax assessments on materials or equipment used until acceptance by NOR.
 - (2) Without limitation, materials furnished and performance by Contractor hereunder shall comply with Safety Orders of the Division of Industrial Safety, State of California, Federal Safety and Regulations of the Bureau of Labor, Department of Labor; and any other applicable Federal regulation.
 - (3) The Contractor upon request shall furnish evidence satisfactory to NOR that any and all of the foregoing obligations have been or are being fulfilled. The Contractor warrants to NOR that it is licensed by all applicable governmental bodies to perform this Contract and will remain so licensed throughout the progress of the Work, and that it has and will have, throughout the progress of the Work, the necessary experience, skill and financial resources to enable it to perform this Contract.
 - (4) Federal Safety Standards. Contractors shall comply with provisions of the Contract Work Hours and Safety Standard Act (40USC 327 et seq.) and the regulations. NOR shall not have liability for non-compliance.

1.56 Correction of Work

- a. The Contractor shall promptly remove from the premises all materials rejected by NOR as failing to conform to the Contract Documents whether incorporated in the Work or not. The Contractor shall, at sole expense, promptly replace such materials and perform all work made necessary by such replacement including the making good of all work of others destroyed or damaged by such removal or replacement.
- b. If the Contractor does not remove such rejected work and materials within a reasonable time, fixed by written notice, NOR may remove them or may store the material at the expense of the Contractor. If the Contractor does not pay for the expense of the removal within ten (10) days thereafter, NOR may, upon ten (10) days written notice, sell such materials at auction or at private sale and shall account for the net proceeds thereof, after deducting all of the costs and expenses that should have been borne by the Contractor. If the proceeds of the sale are not sufficient to reimburse NOR for costs and expenses that should have been borne by the Contractor, the additional costs and expenses shall be paid by the Contractor and may be deducted by NOR from monies due or to become due the Contractor under this Contract.

1.57 Cleanup

- a. During the progress of the Work, the Contractor shall maintain the site and related structures and equipment in a clean, orderly condition and free from unsightly accumulation of rubbish. Upon completion of Work and before the final estimate is submitted, the Contractor shall at its own cost and expense remove from the vicinity of the Work all discarded plants, temporary buildings, rubbish, unused work materials, concrete forms, temporary bridging and other like materials, belonging to it or used under its direction during the construction and in the event of its failure to do so, the same may be removed by NOR after ten (10) calendar days notice to the Contractor, such removal to be at the expense of the Contractor. Where the construction has crossed yards or driveways, they shall be restored by the Contractor to the complete satisfaction of NOR, at the Contractor's expense.

MEASUREMENT AND PAYMENT

1.58 Scope of Payment

- a. The Contractor shall accept the compensation as herein provided as full payment for (a) furnishing all labor, materials, tools, equipment and incidentals necessary to the completed work, (b) performing all work contemplated and embraced under the Contract, (c) loss or damage arising from the nature of the Work or from the action of the elements or from any unforeseen difficulties which may be encountered during the prosecution of the Work until the acceptance by NOR, and for all risks of every description connected with the prosecution of the Work, (d) all expenses incurred in consequence of the suspension or discontinuance of the Work as herein specified, and (e) completing the Work according to the Contract Documents. Neither the payment of any estimate nor of any retained percentage shall relieve the Contractor's obligation to make good any defective work or material.
- b. No compensation will be made in any case for loss of anticipated profits. Increased or decreased work involving supplemental agreements or Extra Work will be paid for as provided in such agreement.

1.59 Measurement of Quantities

- a. Where the Contract provides for payment on a lump sum price basis, no measurement of quantity will be made. Where the Contract provides for payment on a unit price basis, the quantities of work performed will be computed by NOR on the basis of measurements by its representative and these measurements shall be final and binding.
- b. All quantities of work computed under the Contract shall be based upon measurement by NOR according to United States Measurements and Weights.

1.60 Progress Estimates and Payments

- a. For each calendar month of Contract Work, the Contractor will prepare and NOR approve and submit a progress estimate of all work performed under the Contract. Within the first week of each succeeding calendar month, an estimate of the value of all work done under the Contract, including any amounts due the Contractor for Extra Work, change orders, or pursuant to approved claims for extra cost incurred during the preceding month will be prepared. In arriving at the value of the work done, consideration will be given to value of Contractor furnished major items which have been delivered to the job site for incorporation in the Work, provided that a payment in full has been made by the Contractor.
- b. NOR will pay the Contractor ninety percent (90%) of the amount of each progress estimate approximately 2 weeks after receipt of the invoice. Ten percent (10%) of the amount of each

estimate shall be retained by NOR until final completion and acceptance of all Work under the Contract. The Contractor may, in accordance with the provisions of Government Code Section 4590, substitute securities for monies which NOR may withhold to insure performance under this Contract. Provided, however, that if NOR at any time after fifty percent (50%) of the Work has been completed, finds that satisfactory progress is being made, NOR may pay any or all of the remaining progress payments in full.

1.61 Payment of Taxes

- a. The Contract price paid for the Work shall include full compensation for payment of all taxes, whether imposed by Federal, State or local government.

1.62 Warranty of Title

- a. No material, supplies or equipment for work under this Contract shall be purchased subject to any chattel mortgage, security agreement, or under a conditional sale or other agreement by which an interest therein or any part thereof is retained by the seller or supplier. The Contractor warrants good title to all material, supplies and equipment installed or incorporated in the Work and agrees upon completion of all work to deliver to the premises together with all improvements and appurtenances constructed or placed thereon by it to NOR free from any claim, liens, security interest, or charges and further agrees that neither it nor any persons, firm or corporation furnishing any material or labor for any work covered by this Contract shall have any right to a lien upon the premises or any improvement or appurtenances thereon.

1.63 Satisfaction of Liens

- a. If any liens or claims remain unsatisfied after final payment to the Contractor, the Contractor shall pay or refund to NOR any money that the latter may be compelled to pay to discharge such liens and costs together with reasonable attorney's fees incurred by NOR in enforcing the Contractor's obligations hereunder.

1.64 Waiver of Interest

- a. NOR shall have no obligation to pay and the Contractor hereby waives the right to recover interest with regard to monies which NOR is required to withhold by reason of judgement, order, statute, or judicial process.

1.65 Disputes

- a. Except as otherwise specifically provided in the Contract Documents, NOR will decide all claims of the Contractor and all disputes arising under and by virtue of the Contract and its decision whether on the merits or as to the timeliness, shall be final and conclusive unless it is fraudulent, capricious, arbitrary, or so grossly erroneous as to necessarily imply bad faith. Such claim or dispute will be processed and decided as soon as practicable upon its submission and availability of additional supportive information necessary to make a decision.

1.66 Right to Withhold Payments

- a. In addition to all other rights and remedies of NOR hereunder and by virtue of the law, NOR may withhold or nullify the whole or any part of any partial or final payment to such extent as may reasonably be necessary to protect NOR from loss on account of:

- (1) Payments which may be past due and payable for just claims against the Contractor or any Subcontractor for labor or materials furnished for the performance of this Contract.

- (2) For defective work not remedied.
 - (3) For failure of the Contractor to make proper payments to Subcontractors.
 - (4) A reasonable doubt that the Contract can be completed for the balance then unpaid.
 - (5) Damage to work or to property.
 - (6) Failure of the Contractor to keep his work progressing in accordance with the provided time schedule.
 - (7) NOR's costs for Contractor's failure to complete work within the allowed time or as required by the Contract.
 - (8) Failure of Contractor and/or Subcontractors to submit in a timely fashion, correctly completed compliance certifications and payroll sheet forms.
 - (9) Cost of Insurance arranged by NOR due to cancellation or reduction of Contractor's insurance.
 - (10) Contractor/Subcontractor prevailing wage underpayments to protect employees.
- b. Whenever NOR shall, in accordance herewith, withhold any monies otherwise due the Contractor, written notice of the amount withheld and the reasons therefore will be given the Contractor. After the Contractor has corrected the enumerated deficiencies, NOR will promptly pay to the Contractor the amount so withheld. When monies are withheld to protect NOR against claims or liens of mechanics, materialmen, Subcontractors, etc., NOR may, at its discretion, permit the Contractor to deliver a surety bond in terms and amount satisfactory to NOR, indemnifying NOR against any loss or expense. Upon acceptance thereof, NOR shall release to the Contractor monies so withheld.

1.67 Claims for Extra Work

- a. It is hereby mutually agreed that the Contractor shall not be entitled to the payment of any additional compensation for any cause, including any act or failure to act by NOR or the happening of any event, thing, or occurrence, unless he shall have given NOR due written notice of potential claims within ten (10) days after said occurrence.
- b. The Contractor may submit a claim to NOR concerning any matter for which a protest or a notice of potential claim is filed within sixty (60) days following the submission of said protest or notice, unless due to the nature of the claim or the uncompleted state of the Work, it is impracticable to determine the amount or the extent of the claim within such period, in which case a claim may be submitted at the earliest time thereafter that such determination can be made but in no event later than the Final Release by the Contractor.
- c. It is the intention of this Article that the differences between the parties arising under and by virtue of the Contract be brought to the attention of NOR at the earliest time possible in order that such matters may be settled. The Contractor hereby agrees that there shall be no right to additional compensation for any claim that may be based on any act, failure to act, event, thing or occurrence for which no written notice of potential claim as herein required was filed.

1.68 Extra Work

- a. New and unforeseen work necessary to complete the Contract will be classified as Extra Work. NOR shall determine when such work is necessary which is not covered by the Contract prices named in the Proposal Bid.
- b. The Contractor shall do such work and furnish labor, material and/or equipment necessary therefore upon receipt of a change order. No extra work will be paid for unless ordered in writing on an approved change order. A verbal approval by NOR's representative may be given prior to issuance of a written formal change order. This shall be notice to continue with specific work.
- c. Payment for Extra Work shall be determined by one or more of the following methods:
 - (1) Lump Sum – By an acceptable lump sum proposal by the Contractor.
 - (2) Agreed Unit Prices
 - (3) Force Account or Cost Plus Basis as follows:
 - A. Direct Labor Cost: Charges for all the labor furnished and used by the Contractor shall be made for manual classifications up to and including general foremen. It will not include charges for Assistant Superintendents, Superintendents, Office Personnel, Timekeepers, and Maintenance Mechanics. The time charged to Extra Work shall be subject to the daily approval of NOR and evidence of such daily approval shall be submitted with the billing. Labor rates to calculate the costs shall be those basic wages including current employer contributions for fringe benefits and including applicable subsistence and travel allowances, all as actually paid to workmen under collective bargaining agreements or as a regular practice of the employer. No time or charges will be allowed except when the men are actually engaged in the proper, efficient and diligent performance or completion of the Extra Work as authorized. Overtime shall not be worked without prior approval of NOR.
 - B. Equipment Cost: Charges for the rental and operation of the equipment furnished and used by the Contractor shall be made for all prime construction and automotive equipment. It shall not include charges for listed equipment or major tools costing \$1,000.00 or less. Equipment time charges shall be subject to the daily approval of NOR and evidence of such daily approval submitted with the billing. The equipment rental and operation rates used shall be those agreed upon by NOR and the Contractor prior to commencement of the Extra Work and shall include an approved allowance for depreciation. No time or charges will be allowed except when equipment is actually being used for the proper and efficient performance or completion of the Extra Work as authorized.
 - C. Material Costs: Charges for the cost of materials furnished by the Contractor shall be made providing such furnishing was specifically authorized in the Extra Work order and the actual use verified by NOR. Charges shall be net cost to the Contractor delivered at the job, including all applicable sales taxes and vendor's invoice must accompany the billing along with verification of use of such materials by NOR.
 - D. Tools, Supplies, Overhead, Supervision and Profit: These items will be allowed in the amount of fifteen percent (15%) of the total direct labor cost, equipment cost and material cost, as defined above. In addition, for workmen's usage of any or all unlisted small tools having a minute unit cost, each of less than \$1,000.00, NOR will allow a charge of six percent (6%) of the total cost of total basic labor wages, exclusive of fringe benefits and subsistence allowances.

It is understood that labor, materials, and equipment may be furnished by the Contractor, or by the Subcontractor, or by others on behalf of the Contractor. When the Extra Work is

performed by other than the Contractor's organization, the Contractor shall reach an agreement with such other forces as to the distribution of payments. No additional payment therefore will be made by NOR.

In order that a proper determination may be made by NOR of the net cost of labor and materials entering into Extra Work, in accordance with the procedure heretofore stated, the Contractor shall furnish weekly an itemized statement of materials and labor supplied together with the cost of such materials and the wages paid and shall furnish vouchers for quantities and prices of such labor, materials or work. In case the Contractor fails to comply with the above provisions, there shall be no claim for compensation against NOR.

NOR reserves the right to contract with any person or firm other than the Contractor for any or all Extra Work. The Contractor's attention is especially called to the fact that there shall be no entitlement to claims for damages or anticipated profits on any portions of work that may be omitted.

1.69 Final Acceptance and Date of Completion

- a. Upon substantial completion of the Work, the Contractor shall notify NOR and applicable Project Inspector that a final inspection of the Project is needed. During this inspection, which will be arranged as soon as possible, NOR representatives, Contractor and other parties concerned with the contractual requirements will compile a Final Inspection Correction List, incorporating all items or work and corrections required to complete the Project. In addition, at this time the Contractor shall arrange for the delivery of manufacturers' data, manuals, operating instructions and keys to NOR.
- b. Whenever the Contractor shall deem all Work under this Contract to be complete in accordance therewith, NOR shall be so notified in writing and NOR shall promptly ascertain and provide in writing a listing of any additional work required. When all the provisions of the Contract have been fully complied with to the satisfaction of NOR a final estimate for the total value of all work performed by the Contractor will be prepared. The date of completion shall be the date of acceptance of the Work by NOR.

1.70 Final Payment

- a. Within ten (10) days after completion, NOR will file in the office of the County Recorder, a Notice of Completion of the work done herein by the Contractor. On the expiration of thirty-five (35) days after the recordation of such Notice of Completion, the difference between said final estimate and all payments theretofore made to the Contractor shall be due and payable to the Contractor, subject to any requirement concerning the furnishing of a maintenance bond, and excepting any such sum or sums as may lawfully be withheld in accordance with the provisions of the Contract. Contractor shall invoice for this final payment. All prior progress estimates upon which partial payments have been made, being merely estimates shall be subject to correction in the final payment.

1.71 Final Release

- a. Acceptance by the Contractor of the final payment shall operate as and shall be a release to NOR, its officers, agents and employees from all claims and liability to the Contractor for anything done or furnished or withheld and for anything relating to the Work or any act of neglect of NOR, its officers, agents and employees excepting only claims against NOR for any amounts withheld by NOR at the time of such payment.

END OF SECTION

**SECTION 00 73 00
SUPPLEMENTARY CONDITIONS OF THE CONTRACT**

I N D E X

1.01	Definition
1.02	NOR
1.03	Location of Project
1.04	Specification Drawings
1.05	Materials Furnished by NOR
1.06	Progress of the Work and Time of Completion
1.07	Liquidated Damages
1.08	Insurance
1.09	Licenses

SECTION 00 73 00 SUPPLEMENTARY CONDITIONS OF THE CONTRACT

1.01 Definition

- a. These Supplementary Conditions modify, delete from, and/or add to the General Conditions of the Contract.
- b. All conditions, or portions thereof, which are not specifically modified, deleted, or superseded hereby, remain in full effect.
- c. The General Conditions also may be supplemented elsewhere in the Contract Documents by provisions located in, but not necessarily limited to, Division 1 of the Specifications.

1.02 NOR

- a. The term "NOR" refers to North of the River Recreation and Park District's authorized staff or designated representative retained in a consulting capacity to perform various specialized work such as engineering, architecture, surveying, testing, etc.
- b. The term "NOR" shall be used in lieu of all references to owner.

1.03 Location of Project

- a. Address of the Project site is: 401 Willow Drive, 93308.
- b. The Project is in Bakersfield, Kern County, California.

1.04 Specification Drawings

- a. The location of the Work, its general nature and extent, and the form and general dimensions of all appurtenant works are shown on the Drawings included and made a part of these Specifications, entitled: N/A.

1.05 Materials Furnished by NOR

- a. The following equipment and/or materials will be furnished by North of the River Recreation and Park District for use on this project: NONE.
- b. The location of the items is N/A.
- c. The Contractor is responsible to arrange for pick-up of the equipment and/or materials and transportation of the same to the Project site unless otherwise noted.

1.06 Progress of the Work and Time of Completion

- a. The Contractor shall begin work upon receipt of NOR's Notice to Proceed, and shall complete all work under the Contract within fourteen (14) consecutive calendar days of the Notice to Proceed.
- b. The Contractor shall give NOR written notice received not less than 72 hours prior to proposed time of construction. The Contractor shall be entirely responsible for any delay in the work which may be caused by his failure to give such notice.

1.07 Liquidated Damages

- a. General: It is agreed by the parties to the Contract that in case all work called for under the Contract in any parts and requirements is not completed within the number of days specified for such work plus time extensions that may be granted, damage will be sustained by NOR; and it is further agreed that it is, and will be, impractical and extremely difficult to ascertain and determine that actual damage which NOR will sustain by reason of such delay. It is therefore agreed that the Contractor will pay to NOR as fixed, agreed, and liquidated damages the amount of **\$1,000** per day for each calendar day's delay in completion of such work. The Contractor agrees to pay said liquidated damages as herein provided for, and further agrees that NOR may deduct the amount thereof from the monies due or to become due the Contractor under this Contract.

1.08 Insurance

- a. The Contractor shall at its sole expense maintain in effect at all times during the performance of the Work and during the full guarantee period under the Contract not less than the following coverage and limits of insurance, which shall be maintained with insurers having an "AM Best A-VII" or higher rating and under forms of policy satisfactory to NOR.
- b. Workmen's Compensation and Employer's Liability: In accordance with Section 3700 of the Labor Code, every Contractor will be required to secure the payment of compensation to its employees in one or more of the following ways:
 - (1) By being insured against liability to pay compensation by one or more insurers duly authorized to write compensation insurance in this state.
 - (2) By securing from the Director of Industrial Relations a certificate of consent to self-insure, which may be given upon furnishing proof satisfactory to the Director of Industrial Relations of ability to self-insure and to pay any compensation that may become due to the employees.
 - (3) For any county, city, city and county, municipal corporation, public district, public agency, or any political subdivision of the state, including each member of a pooling arrangement under a joint exercise of powers agreement (but not the state itself), by securing from the Director of Industrial Relations a certificate of consent to self-insure against worker's compensation claims, which certificate may be given upon furnishing proof satisfactory to the director of ability to administer worker's compensation claims properly, and to pay worker's compensation claims that may become due to its employees.
 - (4) In accordance with Section 1861 of the Labor Code, each Contractor shall sign and file with NOR the following certification prior to performing the Work of the Contract: "I am aware of the provisions of Section 3700 of the Labor Code which require every employer to be insured against liability for worker's compensation or to undertake self-insurance in accordance with the provisions of that code, and I will comply with such provisions before commencing the performance of the Work of this Contract".
- c. Comprehensive General Liability Coverage: Limits of liability shall be at least One Million Dollars and no/100 (\$1,000,000.00) which shall be a Combined Single Limit on Automobile, Bodily Injury and Property Damage and General Liability and Property Damage. A minimum aggregate of Two Million Dollars and no/100 (\$2,000,000.00) is required for this project. The Bodily Injury and Property Damage Liability policy or policies shall contain the following:
 - (1) Provision or endorsement naming North of the River Recreation and Park District, its consultants, its officers, employees, agents, Boards and Commissions as additional insured as respects liabilities arising out of the performance of any Work under the Contract and providing that such insurance is primary insurance as respects the interest of the agency and its agents

that any other insurance maintained by NOR and its agents is excess and not contributing insurance with that required hereunder.

- (2) "Cross Liability" or "Severability of Interest" Clause.
- (3) Broad Form Property Damage, Contractual Liability. Protective Liability and Completed Operations coverages and elimination of any exclusion regarding loss or damage to property caused by explosion or resulting from collapse of buildings or structures or damage to property underground, commonly referred to by insurers as the "XCU" hazards.
- (4) Provision or endorsement stating that such insurance, subject to all of its other terms and conditions, applies to the liability assumed by the Contractor under this Contract, including without limitation that set forth in Section 00 72 00 General Conditions, 1.22 "Indemnity and Litigation Costs."

1.09 Licenses

- a. The Contractor shall be a licensed Contractor in the State of California certified to perform the Work of the Project. This Project requires a class California C-15 Flooring and Floor Covering or approved combination of Contractor's license(s).

END OF SECTION

**SECTION 00 91 13
ADDENDA**

Addendum #1: Bid form revisions, pre-bid walk clarifications and changes to mandatory requirements.

END OF SECTION

SECTION 00 63 13 REQUEST FOR INFORMATION FORM

Project: Riverview Community Center
Flooring Replacement
To: North of the River Recreation & Park District
Re: Bid Package Clarifications

R.F.I. #: 1
From: NOR Rec & Park District
Date: July 2, 2020
Proj. #: RV-1-2021

Specification Section: _____ Paragraph: _____ Drawing Sheet: _____ Detail: _____
Request: _____

Signed By: _____ Printed Name: _____ Date: _____
Response: _____

The skilled and trained workforce form incorporated in the bid package was done in error; this requirement is for design/build projects, which this project is not. The form shall not be considered as part of the bid package.

Due to COVID-19 orders, the District recognizes that individuals may not be comfortable conducting a group mandatory bid walk. Therefore, NOR will make the modification to allow potential contractors to schedule a separate bid walk with staff. A job site walk shall be required for the bid and appointments for said walks can be scheduled by contacting Josh Herrboldt at 661-392-2000. All contractors shall sign the sign-in sheet as proof of attendance.

Because of unknown subgrade factors, potential contractors should note the changes to the bid form to account for leveling and moisture barrier. These line items shall be per square foot, with the understanding that once the existing floor is demolished, the District and contractor can come to a conclusion of how much treatment the foundation will need.

Attachments:

Response From: [Signature] To: Contractors Date Rec'd: _____ Date Ret'd: _____
Signed by: [Signature] Printed Name: STEPHANIE SANDERS Date: 07.02.2020
Copies: Owner Consultants File

END OF SECTION



Division 01 00 00 General Requirements

SECTION 01 11 00 SUMMARY OF WORK

PART I - GENERAL

1.01 Application of the Contract and Inclusion of Division 1

- a. The Contract, General and Supplementary Conditions of the Contract and all sections of Division 1 apply in full to all other divisions and sections of these Specifications as though included therein.

1.02 Description

- a. The Work comprises the completed construction required by the Contract Documents and includes all labor necessary to produce such construction and all materials and equipment incorporated or to be incorporated in such construction. The following is only a partial list of the work required and is not to be construed as binding in any way. The Contractor is responsible for estimating the actual work required.

(02) Existing Conditions: NOT APPLICABLE

(03) Concrete: NOT APPLICABLE

(04) Masonry: NOT APPLICABLE

(05) Metals: NOT APPLICABLE

(06) Wood, Plastics, and Composites: NOT APPLICABLE

(07) Thermal & Moisture Protection: NOT APPLICABLE

(08) Openings: NOT APPLICABLE

(09) Finishes:

- 09 65 19.23 - Vinyl Tile Flooring

(10) Specialties: NOT APPLICABLE

(11) Equipment: NOT APPLICABLE

(12) Furnishings: NOT APPLICABLE

(13) Special Construction: NOT APPLICABLE

(14) Conveying Equipment: NOT APPLICABLE

(15) Not Used

(16) Not Used

(17) Not Used

(18) Not Used

- (19) Not Used
- (20) Not Used
- (21) Fire Suppression: NOT APPLICABLE
- (22) Plumbing: NOT APPLICABLE
- (23) Heating, Venting, and Air Conditioning (HVAC): NOT APPLICABLE
- (24) Not Used
- (25) Integrated Automation: NOT APPLICABLE
- (26) Electrical: NOT APPLICABLE
- (27) Communications: NOT APPLICABLE
- (28) Electronic Safety and Security: NOT APPLICABLE
- (29) Not Used
- (30) Not Used
- (31) Earthwork: NOT APPLICABLE
- (32) Exterior Improvements: NOT APPLICABLE
- (33) Utilities: NOT APPLICABLE
- (34) Transportation: NOT APPLICABLE
- (35) Waterway and Marine Construction: NOT APPLICABLE
- (36) Not Used
- (37) Not Used
- (38) Not Used
- (39) Not Used
- (40) Process Interconnections: NOT APPLICABLE
- (41) Material Processing and Handling Equipment: NOT APPLICABLE
- (42) Process Heating, Cooling, and Drying Equipment: NOT APPLICABLE
- (43) Process Gas and Liquid Handling, Purification, and Storage Equipment: NOT APPLICABLE
- (44) Pollution and Waste Control Equipment: NOT APPLICABLE
- (45) Industry-Specific Manufacturing Equipment: NOT APPLICABLE

(46) Water and Wastewater Equipment: NOT APPLICABLE

(47) Not Used

(48) Electrical Power Generation: NOT APPLICABLE

1.03 Work Provided by Others

- a. The following work or products shall be provided by NOR and coordinated with the Contractor's work: NOT APPLICABLE.

1.04 Permits and Fees

- a. The Contractor shall pickup all permits, licenses, and fees required by all governing entities and necessary for successful completion of the Project (NOR will pay building permit and plan review fees). The Contractor is responsible to abide by governing codes and regulations, obtaining inspections, approvals and tests which may be required. Inspection sign-off cards, notices of non-compliance, field plans or other correspondence with governing agencies are property of NOR and shall be returned to NOR after all county or city inspections and approvals are complete.

PART II – PRODUCTS

2.01 Materials and Equipment

- a. The following is only a partial list of materials and equipment to be provided by the Contractor as components of this work: SEE SPECIFICATIONS.

PART III – EXECUTION

3.01 Site Visitation

- a. The General Contractor shall visit the site to review all existing conditions of the premises that may have a bearing on the performance of the Work. Furthermore, the Contractor will personally inspect the grounds for comparison with pertinent sections of the Drawings and Specifications and will immediately notify NOR of any discrepancies. No allowance can subsequently be made on behalf of a Contractor for errors due to negligence in failing to be acquainted with the existing site conditions.

3.02 Layout of Work

- a. Field surveys for control of all grading, construction and layout shall be the responsibility of the Contractor. All such surveys, including construction staking, shall be under the supervision of a California licensed surveyor or civil engineer. Staking shall be performed on all items ordinarily requiring grade and alignment at intervals normally accepted by the agencies and trades involved. Payment of construction survey staking shall be considered as included in the various items of work and no additional allowance will be made therefore.

3.03 Installation

- a. The Contractor shall provide and perform skillful craftsmanship using appropriate tools with current and lawful methods to complete the Work according to the Contract, Plans and Specifications. Knowledge of and compliance with codes, regulations and procedures of governing agencies, as well as attention to manufacturer's recommendations shall be expected of the Contractor and all employees.

END OF SECTION

SECTION 01 23 00 ALTERNATES

PART I – GENERAL

1.01 Description

- a. Work Included: To allow NOR to compare total costs where alternate materials and methods might be used, and to enable NOR's decision prior to awarding the Contract, certain alternatives have been established.
- b. Related Work Described Elsewhere:
 - (1) Pertinent sections of these Specifications describe the materials and methods required for the various alternatives.
 - (2) The method for stating the proposed Contract Sum is described on the Bid form.

1.02 Submittals

- a. Limit of Alternatives:
 - (1) Do not submit alternatives other than those described in the section of these Specifications.
 - (2) Submit proposed Contract Sums reflecting all alternatives as required on the Bid Form.
- b. Other Submittals:
 - (1) Normal submittals for the various items are described in pertinent sections of these Specifications.
 - (2) No special submittal of materials or methods for the alternatives is required other than as described in the pertinent sections.

PART II – PRODUCTS

2.01 Coordination of Alternatives

- a. Use all means necessary to properly coordinate NOR's ultimate selection of alternatives into the Work and to ensure proper and adequate provision for the installation of all selected materials and methods.

PART III – EXECUTION

3.01 Product Handling

- a. If NOR elects to proceed on the basis of one or more of the alternatives, make all modifications to the Work required in the furnishing and installation of the selected alternatives to the approval of the Engineer and at no additional cost to NOR, except as proposed on the Bid Form.

END OF SECTION

SECTION 01 25 00 SUBMITTAL AND SUBSTITUTION PROCEDURES

PART I – GENERAL

1.01 Description

- a. Wherever possible throughout the Contract Documents, the minimum acceptable quality of workmanship and materials has been defined, either by manufacturer's name and catalog number or by compliance with recognized industry standards. All products specified are the standard for this Project. Products proposed to be substituted for those specified on the Project must be submitted for approval prior to use. Follow the process described in this section for all products proposed to be substituted. To ensure that the desired products are furnished and installed in accordance with the design intent, certain procedures are established for the advance submittal of design data and its approval or rejection by the Engineer.

1.02 Related Work Described Elsewhere

- a. Submittals required for the various portions of the Work are included in the sections of these Specifications pertaining to the Work involved. Occasionally it is included in the Drawings for miscellaneous items of equipment, materials or procedures.

1.03 Product Handling

- a. Make all submittals of shop Drawings, samples and requests for substitution in accordance with the provisions of these Specifications.

PART II – PRODUCTS

2.01 Schedule of Submittals

- a. Submittals required by the respective Specifications shall be submitted according to the "General Conditions" item 1.36.

2.02 Shop Drawings and Product Information Submittals

- a. Unless otherwise specifically directed by the Engineer, make all shop Drawings accurately to a scale sufficiently large to show all pertinent features of the item and its method of connection and interface to the Work.
- b. Submit all shop Drawings in the form of one reproducible sepia and sufficient blue line prints of each shop drawing so that NOR can keep one copy plus the reproducible sepia and the Contractor will have sufficient copies for its needs. In the case of product information, submit sufficient copies so that NOR may keep two (2) copies and the Contractor shall have adequate copies for their needs. Where contents of submitted product information include data not pertinent to the submittal, clearly indicate which portion is being submitted for review.
- c. Copies that are not needed by NOR will be returned to the Contractor for its use.

2.03 Samples

- a. Samples shall be provided according to the provisions of the "General Conditions" item 1.37 Samples.

2.04 Colors

- a. Prepare color samples for products as described by the "General Conditions" item 1.38 Colors. Unless the precise color and pattern is specifically described in these Contract Documents, whenever a choice of color or pattern is available in a specified product submit accurate color charts and pattern charts to NOR for its review and selection.

2.05 Manuals

- a. Manuals shall be provided according to item 1.41 Manuals of the "General Conditions."

2.06 Record Drawings

- a. Record drawings are required according to the provisions of the "General Conditions" item 1.40 Record Drawings.

2.07 Substitutions

- a. Substitutions may be approved if they meet the requirements of item 1.33c Substitutions of the "General Conditions."

PART III – EXECUTION

3.01 Coordination

- a. Prior to submittal for Engineer's review:
 - (1) Fully coordinate all submittals by determining and verifying all field dimensions and conditions, materials, catalog numbers, and similar data. Each submittal must bear the General Contractor's approval stamp indicating that it has determined and verified that the submittal data meets the requirements of the project. The stamp must include the date and initial of the responsible reviewer.
 - (2) Coordinate as required with all other trades and with all public agencies involved.
 - (3) Secure all necessary prior approvals and signify by stamp, or other means, that they have been secured.
 - (4) Clearly indicate all deviations from the Contract Documents.

3.02 Identification of Submittals or Substitutions

- a. Name and address of submitter, plus name and telephone number of individual who may be contacted for further information.
- b. Name of project.
- c. Drawing number and Specification section number to which the submittal applies.

3.03 Timing of Submittals

- a. Costs of delays occasioned by tardiness of submittals may be back-charged as necessary and shall not be borne by NOR. In general, no submittals of a finish nature will be reviewed until all such submittals are received by the Engineer.

3.04 Engineer's Review

- a. The Engineer's review will be only for conformance with the design concept and with the information given in the Contract Documents. The Engineer's review and approval of shop drawings and samples shall not relieve the Contractor of responsibility for deviation from the requirements of the Contract Documents unless the Contractor has informed the Engineer in writing of such deviation at the time of submittal and the Engineer has given written approval to the specific deviation. The Engineer's approval shall not relieve the Contractor from responsibility for errors and omissions in the shop drawings and samples.

3.05 Compliance with Approvals

- a. Do not commence any portion of the Work requiring approval of shop Drawings or samples by the Engineer until the submittal has been approved by the Engineer. All such portions of the Work shall be in accordance with the Engineer approved shop Drawings and samples.

END OF SECTION

SECTION 01 31 19 PROJECT MEETINGS

PART I – GENERAL

1.01 Description

- a. **Work Included:** To enable orderly review during progress of the work, and to provide for systematic discussion of problems, NOR may conduct Project meetings throughout the construction period. The frequency of meetings will be determined based on needs and related to the complexity of the Project.
- b. **Related Work:** The Contractor's relations with his subcontractors and materials suppliers, and discussions relative thereto, are the Contractor's responsibility and normally are not included as part of Project meetings.

1.02 Quality Assurance

- a. Persons designated by the Contractor to attend and participate in Project meetings must have sufficient authority to commit the Contractor to solutions agreed upon in the Project meetings.

1.03 Agendas

- a. **Agenda Items:** To the maximum extent practicable, advise NOR at least 24 hours in advance of Project meetings regarding items to be added to the agenda.
- b. **Minutes:** When meetings are held where both the general contractor and subcontractors are required to be present, NOR will compile minutes of the project meeting and furnish a copy to the Contractor. The Contractor is responsible to communicate this information to its subcontractors employed on the Project.

PART II – PRODUCTS

(No products are required in this Section)

PART III – EXECUTION

3.01 Meeting Schedule

- a. Project meetings will usually be held at a frequency mutually agreed upon with the Contractor.
- b. Coordinate as necessary to establish a mutually acceptable schedule for meetings.

3.02 Meeting Location

- a. NOR will establish the meeting location. To the maximum extent practicable, meetings will be held at the job site.

3.03 Preconstruction Meeting

- a. A preconstruction meeting will be scheduled within fifteen (15) working days after NOR has awarded the Contract.

- (1) The Contractor and major subcontractors should have authorized representatives in attendance.
- (2) NOR will advise other interested parties and request their attendance.

3.04 Project Meetings

a. Attendance:

- (1) To the maximum extent practicable, assign the same person or persons to represent the Contractor at Project meetings throughout the Project.
- (2) Subcontractors, materials suppliers, and others may be invited to attend Project meetings in which their aspect of the work is involved.

b. Minimum Agenda:

- (1) Review, revise as necessary, and approve minutes of previous meetings.
- (2) Review progress of the work since last meeting, including status of submittals for approval.
- (3) Identify problems which impede planned progress.
- (4) Develop corrective measures and procedures to regain planned schedule.
- (5) Complete other current business.

c. Revisions to Minutes:

- (1) Unless published minutes are challenged in writing prior to the next regularly scheduled progress meeting, they will be accepted as properly stating the activities and decisions of the meetings.
- (2) Persons challenging published minutes shall reproduce and distribute copies of the challenge to all indicated recipients of the particular set of minutes.
- (3) Challenges to the minutes shall be settled at the next regularly scheduled meeting.

END OF SECTION

SECTION 01 32 33 PHOTOGRAPHIC DOCUMENTATION

PART I - GENERAL

1.01 RELATED DOCUMENTS

- A. Drawings and general provisions of the Contract, including General and Supplementary Conditions and other Division 01 Specification Sections, apply to this Section.

1.02 SUMMARY

- A. This Section includes administrative and procedural requirements for the following:
 - 1. Preconstruction photographs.
 - 2. Periodic construction photographs.
- B. See CSI Section 01 78 00, Closeout Submittal, for submitting digital media as Project Record Documents at Project closeout.

1.03 SUBMITTALS

- A. Key Plan: Submit key plan of Project site and building with notation of vantage points marked for location and direction of each photograph. Indicate elevation or story of construction. Include same label information as corresponding set of photographs.
 - 1. Digital Images: Submit a complete set of digital image electronic files with each submittal of prints on CD-ROM or USB flash drive (not to be returned). Identify electronic media with date photographs were taken. Submit images that have same aspect ratio as the sensor, uncropped.

PART II - PRODUCTS

2.01 PHOTOGRAPHIC MEDIA

- A. Digital Images: Provide images in uncompressed TIFF or JPEG/JPG format, produced by a digital camera with minimum sensor size of 8.0 megapixels, and at an image resolution of not less than 1024 by 768 pixels.
- B. Digital Video: Provide video with minimum specifications 1080p at 60 fps or 720p at 240 fps are acceptable, where- as HDR is preferred.

PART III - EXECUTION

3.01 CONSTRUCTION PHOTOGRAPHS

- A. General: Take photographs using the maximum range of depth of field, and that are in focus, to clearly show the Work. Photographs with blurry or out-of-focus areas will not be accepted.

1. Maintain key plan with each set of construction photographs that identifies each photographic location.
- B. Digital Images: Submit digital images exactly as originally recorded in the digital camera, without alteration, manipulation, editing, or modifications using image-editing software.
1. Date and Time: Include date and time in filename for each image.
 2. Field Office Images: Maintain one set of images on CD-ROM or USB flash drive in the field office at Project site, available at all times for reference. Identify images same as for those submitted to Architect.
- C. Preconstruction Photographs: Before starting construction, take, digital photographs of Project site and surrounding properties, including existing items to remain during construction, from different vantage points, as directed by Owner.
1. Flag construction limits before taking construction photographs.
 2. Take a minimum eight photographs to show existing conditions adjacent to property before starting the Work.
 3. Take a minimum eight photographs of existing buildings either on or adjoining property to accurately record physical conditions at start of construction.
- D. Periodic Construction Photographs: Take a minimum 12 digital photographs weekly, with timing each month adjusted to coincide with the cutoff date associated with each Application for Payment. Select vantage points to show status of construction and progress since last photographs were taken.

END OF SECTION

SECTION 01 45 00 TESTING LABORATORY SERVICES

PART I – GENERAL

1.01 Description

a. Work Included:

- (1) From time to time during progress of the Work, NOR may require that testing be performed to determine that materials provided for the Work meet the specified requirements.
- (2) Such testing may include, but is not necessarily limited to: Concrete, structural steel, reinforcing steel, irrigation and plumbing pressure tests and backflow prevention device operation.
- (3) Cooperate with NOR's selected testing agency and all others responsible for testing and inspecting the Work. Contractor shall coordinate the required tests with the testing entity.
- (4) Provide testing and inspecting specified to be furnished by the Contractor in this section and/or elsewhere in the Contract Documents.

b. Related Work Described Elsewhere:

- (1) Requirements for testing may be described in various sections of these Specifications and the General Conditions of the Contract.
- (2) Where no testing requirements are described, but NOR decides that testing is required, NOR may require testing to be performed under current recognized standards for testing.

c. Work Not Included:

- (1) Selection of testing laboratory: NOR will select an independent testing laboratory.
- (2) Payment for initial testing services: NOR will pay for all initial services of the testing agency as further described in item 2.01 of this section.

1.02 Quality Assurance

- a. Codes and Standards: Testing, when required, will be in accordance with all pertinent codes and regulations and with selected standards of the American Society for Testing and Materials.
- b. Qualifications of Testing Laboratory: The testing laboratory will be qualified to NOR's approval for the type of testing desired.

1.03 Product Handling

- a. Promptly process and distribute all required copies of test reports and related instructions to ensure all necessary retesting and/or replacement of materials with the least possible delay in progress of the Work.

PART II – PRODUCTS

2.01 Payment for Testing Services

- a. Initial Services: NOR will pay for all initial testing services requested or required by codes or ordinances.
- b. Retesting: When the initial test indicates non-compliance with the Contract Documents, all subsequent retesting occasioned by that non-compliance shall be performed by the same agency and the costs thereof will be deducted by NOR from the Contract Sum.

2.02 Code Compliance Testing

- a. Inspections and tests required by codes or ordinances or by a plan approval authority, and made by a legally constituted authority, shall be the responsibility of and shall be paid for by the Contractor, unless otherwise provided in the Contract Documents.

2.03 Contractor's Convenience Testing

- a. Inspection and testing performed exclusively for the Contractor's convenience shall be the sole responsibility of the Contractor.

PART III – EXECUTION

3.01 Cooperation with Testing Agency

- a. Access to the Work:
 - (1) Representatives of the testing laboratory shall have access to the work at all times.
 - (2) Contractor shall provide all required facilities for such access in order that the agency may properly perform its functions.
 - (3) The soils Engineer shall be provided 48 hours advance notice in order to be present at the site during all earthwork activities related to excavation, stripping, backfill and compaction and filling of the site; and to perform periodic compaction tests so that substantial conformance to these recommendations can be established.

3.02 Test Reports

- a. Test reports and verification of test reports of all tests and inspections shall be sent to the Contractor, Engineer, Structural Engineer, NOR and Building Inspector.

END OF SECTION

SECTION 01 50 00 TEMPORARY FACILITIES AND CONTROLS

PART I – GENERAL

1.01 Description

- a. Temporary facilities and controls required for this project include, but are not necessarily limited to: temporary utilities such as water, electricity and telephone; field offices and shed; fencing of the construction area; access roads; enclosures such as tarpaulins, barricades and canopies; sanitary facilities; and scaffolding. All such temporary facilities shall be located for convenience and safety and maintained in a safe and sanitary condition at all times until completion of the Contract, then removed from the site.

1.02 Related Work Described Elsewhere

- a. Utility Hook-Up: Install and hook-up the various utility lines described in pertinent sections of the Specifications and/or on the Drawings.

1.03 Compliance with Codes and Regulations

- a. Compliance with all requirements of pertinent safety regulations is described in the General Conditions of the Contract for Construction and shall include, but shall not necessarily be limited to: Industrial Safety, California Administrative Code, Title 8; Public Safety, California Administrative Code, Title 24 Uniform Building Code.

1.04 Product Handling

- a. Use all means necessary to maintain all temporary facilities and controls in proper and safe condition throughout progress of the Work. In the event of damage or loss, immediately make all repairs and replacements necessary and at no additional cost to NOR.

PART II – PRODUCTS

2.01 Temporary Utilities

- a. General: Provide and pay all costs for all utilities required for performance of the Work. Provide safe distribution of required utilities to the job areas for use of all trades.
- b. Temporary Gas and Water: Furnish and install all necessary temporary piping and, upon completion of the work, remove all such temporary piping.
- c. Temporary Electricity: Furnish and install all necessary temporary wiring; furnish and install area distribution boxes within 100 feet of each portion of the Work so located that the individual trades may use their own construction type extension cords to obtain adequate power and lighting at all points where required by inspectors and for safety.
- d. Telephone: Maintain in the Contractor's field office or in a protected location on the job site a telephone for the use of the subcontractors; the telephone may be coin operated.

2.02 Fencing of the Construction Area

- a. Fencing of the construction area is at the Contractor's discretion. The Contractor shall take whatever precautions it feels necessary to protect the Project while work is in progress.

2.03 Access Facilities

- a. The General Contractor shall provide such access facilities to the construction area as are necessary and required for carrying on the work and the same shall be kept passable at all times. It shall be responsible for any damage to streets, curbs, and sidewalks due to the use of such facilities, and such damaged portions shall be repaired as required to place them in as good condition as existed before commencement of the Work. Contractors shall comply in every respect with applicable building codes regarding the use of public streets and sidewalks and the proper barricading and lighting of public thoroughfares surrounding the construction activities.

2.04 Enclosures, Tarpaulins, Barricades and Canopies

- a. Furnish, install and maintain for the duration of construction, all required scaffolds, tarpaulins, barricades, canopies, warning signs, steps, bridges, platforms and other temporary construction necessary for proper completion of the work in compliance with all pertinent safety regulations. In addition, it is recommended that all existing improvements which are not to be altered or moved be protected by means of temporary barricades or other suitable means.

2.05 Pumping

- a. Keep the site, excavations and structures free of accumulation of water at all times, whether from underground seepage, rainfall, drainage or broken utility lines.

2.06 Sanitary Facilities

- a. Temporary toilet arrangements should be made to accommodate construction workers. Sanitary facilities provided on site must comply with the requirements of the "General Conditions" item 1.06 Sanitary Facilities.

PART III – EXECUTION

3.01 Special Conditions of the Site

- a. The area to be set aside for the use of the Contractor is indicated on the Drawings as "Limit of Work." If work covers an entire site, the limits are the site boundary. Except for subsurface utility work, temporary roads and other work specifically shown or noted, the Contractor shall confine his exterior operations within the limits of work so indicated.
- b. Work shall not proceed for the site or buildings, if used, until all temporary work such as fences, barricades, job office and sanitary facilities are furnished and installed.
- c. Parking of vehicles by the construction personnel shall be limited to areas acceptable to NOR.

3.02 Material Storage and Protection

- a. During the progress of the Work, products and materials shall be neatly stored in accordance with the appropriate manufacturer's recommendations and shall be properly cared for and protected from weather, vandalism and theft.

- b. All installed products and materials shall be adequately protected until such time that NOR accepts the Project.

3.03 Conditions at the Site

- a. The Contractor shall make all necessary inspections of the job site and of the work to be fully aware of the conditions of all temporary facilities and controls at all times.
- b. Storage of materials during progress of the Work shall be within the "Limits of Work," neatly stacked at points acceptable to NOR. They must be properly cared for and protected from weather, theft and vandalism.
- c. The Contractor shall make a close inspection of all materials when delivered and shall promptly return all defective materials without waiting for their rejection by the Engineer.

3.04 Removal

- a. Maintain all temporary facilities and controls as long as needed for the safe and proper completion of the Work. Remove all such temporary facilities and controls as rapidly as progress of the Work will permit, or as directed by the Engineer.

3.05 Restoration of Area

- a. Upon completion of the Project, all temporary facilities shall be removed from the site and all areas not otherwise improved but which were adversely affected by the Contractor's work shall be returned to their original condition to the satisfaction of NOR.

3.06 Final Site Cleanup

- a. Prior to final inspection, thoroughly clean the entire site and put it into a neat, acceptable condition. Remove from the entire site all construction waste and unused materials, dunnage, loose rock and stones, excess earth, roots, weeds and all debris of any description resulting from the work. Hose down and scrub where necessary all new concrete and asphalt pavement dirtied as a result of the work. Thoroughly remove mortar droppings from concrete walks and other pavements.

END OF SECTION

SECTION 01 71 23 FIELD ENGINEERING

PART I – GENERAL

1.01 Description

- a. Work Included: Provide such field engineering services required for proper completion of the work including, but not necessarily limited to:
 - (1) Establishing and maintaining grades, lines and levels.
 - (2) Structural design of shores, forms, and similar items provided by the Contractor as part of the means and methods of construction.
 - (3) Layout of elements of construction.
- b. Related Work:
 - (1) Additional requirements for field engineering also may be described in other sections of these Specifications.

1.02 Quality Assurance

- a. Use adequate numbers of skilled workmen who are thoroughly trained and experienced in the necessary crafts and who are completely familiar with the specified requirements and the methods needed for proper performance of the work of this section.

1.03 Submittals

- a. Comply with pertinent provisions of the General Conditions.
- b. Upon request of NOR submit:
 - (1) Data demonstrating qualifications of persons proposed to be engaged for field engineering services.
 - (2) Documentation verifying accuracy of field engineering work.
 - (3) Certification that elevations and locations of improvements are in conformance or nonconformance with requirements of the Contract Documents.

1.04 Procedures

- a. In addition to procedures directed by the Contractor for proper performance of the Contractor's responsibilities:
 - (1) Locate and protect control points before starting work on the site.
 - (2) Preserve permanent reference points during progress of the work.

- (3) Do not change or relocate reference points or items of the work without specific approval from NOR.
- (4) Promptly advise NOR when a reference point is lost or destroyed, or requires relocation because of other changes in the work.
 - A. Reset or replace lost or destroyed reference stakes or markers.
 - B. Locate such replacements according to the original survey control.
 - C. Resetting of grade stakes shall be at Contractor's expense.

END OF SECTION

SECTION 01 73 29 CUTTING AND PATCHING

PART I – GENERAL

1.01 Description

- a. Work Included: This section establishes general requirements pertaining to cutting (including excavating), fitting and patching of the work required to:
 - (1) Make the several parts fit properly.
 - (2) Uncover work to provide for installing, inspecting, or both, of ill-timed work.
 - (3) Remove and replace work not conforming to requirements of the Contract Documents.
 - (4) Remove and replace defective work.
- b. Related Work:
 - (1) In addition to other requirements specified, upon NOR's request uncover work to provide for inspection by NOR of covered work, and remove samples of installed materials for testing.
 - (2) Do not cut or alter work performed under separate contracts without NOR's written permission.

1.02 Quality Assurance

- a. Use adequate numbers of skilled workmen who are thoroughly trained and experienced in the necessary crafts and who are completely familiar with the specified requirements and the methods needed for proper performance of the work of this section.

1.03 Submittals

- a. Request NOR's Consent:
 - (1) Prior to cutting which effects structural safety, submit written request to NOR for permission to proceed with cutting.
 - (2) Should conditions of the Work, or schedule, indicate a required change of materials or methods for cutting and patching, so notify NOR and secure written permission and the required Change Order prior to proceeding.
 - (3) Submit written notice to NOR designating the time the work will be uncovered, to provide for NOR's observation.

PART II – PRODUCTS

2.01 Materials

- a. For replacement of items removed, use materials complying with pertinent sections of these Specifications.

2.02 Payment for Costs

- a. Perform required cutting and patching needed to comply with the Contract Documents at no additional cost to NOR. NOR will reimburse the Contractor for extra cutting and patching performed pursuant to the written Change Order after claim for such reimbursement is submitted by the Contractor.

PART III – EXECUTION

3.01 Surface Conditions

- a. Inspection:
 - (1) Inspect existing conditions, including elements subject to movement or damage during cutting, excavating, patching and backfilling.
 - (2) After uncovering the work, inspect conditions affecting installation of new work.
- b. Discrepancies:
 - (1) If uncovered conditions are not as anticipated, immediately notify NOR and secure needed directions.
 - (2) Do not proceed until unsatisfactory conditions are corrected.

3.02 Preparation Prior to Cutting

- a. Provide required protection including, but not necessarily limited to shoring, bracing, and support to maintain structural integrity of the work.

3.03 Performance

- a. Perform required excavating and backfilling as required under pertinent other sections of these Specifications.
 - (1) Perform cutting and demolition by methods which will prevent damage to other portions of the work and provide proper surfaces to receive installation of repair and new work.
 - (2) Perform fitting and adjusting of products to provide finished installation complying with the specified tolerances and finishes.

END OF SECTION

SECTION 01 74 00 CLEANING AND WASTE MANAGEMENT

PART I – GENERAL

1.01 Description

- a. Work Included: Throughout the construction period, maintain the buildings and site in a standard of cleanliness as described in this section.
- b. Related Work: In addition to standards described in this section, comply with requirements for cleaning as described in pertinent other sections of these Specifications.

1.02 Quality Assurance

- a. Conduct daily inspections, and more often if necessary, to verify that requirements for cleanliness are being met.
- b. In addition to the standards described in this section, comply with pertinent requirements of governmental agencies having jurisdiction.

PART II – PRODUCTS

2.01 Cleaning Materials and Equipment

- a. Provide required personnel, equipment and materials needed to maintain the specified standard of cleanliness.

2.02 Compatibility

- a. Use only cleaning materials and equipment which are compatible with the surface being cleaned, as recommended by the manufacturer of the material.

PART III – EXECUTION

3.01 Progress Cleaning

- a. General:
 - (1) Retain stored items in an orderly arrangement allowing maximum access. The items should not impede traffic or drainage. Provide required protection of materials.
 - (2) Do not allow accumulation of scrap, debris, waste material and other items that are not required for construction.
 - (3) At least twice each month, and more often if necessary, completely remove all scrap, debris, and waste material from the job site.
 - (4) Provide adequate storage for all items awaiting removal from the job site. Observe requirements for fire and environmental protection.

b. Project Site Cleaning:

- (1) Daily, and more often if necessary, inspect the site and pick up all scrap, debris and waste material. Remove such items to the place designated for their storage.
- (2) Weekly, and more often if necessary, inspect all arrangements of materials stored on the site, repositioning and cleaning items as needed.
- (3) Maintain the site neat and orderly at all times.

c. Preparatory Cleaning:

- (1) As required, preparatory to installation of succeeding materials, clean the structures or pertinent portions thereof to the degree recommended by the manufacturer of the succeeding material. Use equipment and materials recommended by product manufacturers to achieve the necessary cleanliness.
- (2) Following the installation of finish floor materials, clean and protect the finish floor from all sources of damaging elements.

3.02 Final Cleaning

a. General:

- (1) "Clean," for the purpose of this Article, and except as may be specifically provided otherwise, shall mean the level of cleanliness generally provided by skilled cleaners using commercial quality building maintenance equipment and materials.
- (2) Prior to completion of the Work, remove from the job site all tools, surplus materials, equipment, scrap, debris and waste. Leave all items thoroughly cleaned ready for use.

b. Site:

- (1) Unless otherwise specifically directed by NOR, broom clean and wash paved areas on the site and public paved areas adjacent to the site.
- (2) Completely remove resultant debris.

c. Structures:

- (1) Visually inspect surfaces and remove all traces of soil, waste materials, smudges and other foreign matter.
- (2) Remove all traces of splashed materials from finished and adjacent surfaces.
- (3) If necessary to achieve a uniform degree of cleanliness, hose down the exterior of the structure.
- (4) In the event of stubborn stains not removable with water, light sandblasting or other cleaning may be required at no additional cost.
- (5) Glass - clean inside and outside leaving surfaces free of streaks.

- (6) Polished surfaces - if surfaces require routine application of buffed polish, apply the polish according to manufacturer's recommendations.

3.03 Cleaning During Owner's Occupancy

- a. Should NOR occupy the Work or any portion thereof prior to its completion by the Contractor, the Contractor shall appropriately clean the project site. Responsibilities for cleaning shall then be accomplished by NOR.

END OF SECTION

SECTION 01 74 19 CONSTRUCTION WASTE MANAGEMENT AND DISPOSAL

PART I – GENERAL

1.01 Description

- a. Drawings and general provisions of the Contract, including General and Supplementary Conditions and other Division 1 Specification Sections, apply to this Section.

1.02 Summary

- a. Section includes administrative and procedural requirements for the following:
 - 1. Salvaging non-hazardous demolition waste.
 - 2. Disposing of non-hazardous demolition and construction waste.

1.03 Terminology

- a. Construction Waste: Building and site improvement materials and other solid waste resulting from construction, remodeling, renovation or repair operations. Construction waste includes packaging.
- b. Demolition Waste: Building and site improvement materials resulting from demolition or selective demolition operations.
- c. Disposal: Removal off-site of demolition and construction waste and subsequent sale, recycling, reuse or deposit in landfill or incinerator acceptable to authorities having jurisdiction.
- d. Recycle: Recovery of demolition or construction waste for subsequent processing in preparation for reuse.
- e. Salvage: Recovery of demolition or construction waste and subsequent sale or reuse in another facility.
- f. Salvage and Reuse: Recovery of demolition or construction waste and subsequent incorporation into the Work.

1.04 Performance Requirements

- a. General: Facilitate recycling and salvage of materials as required.

1.05 Informational Submittals

- a. Recycling and Processing Facility Records: Indicate receipt and acceptance of recyclable waste by recycling and processing facilities licensed to accept them. Include manifests, weight tickets, receipts and invoices.
- b. Landfill and Incinerator Disposal Records: Indicate receipt and acceptance of waste by landfills and incinerator facilities licensed to accept them. Include manifests, weight, tickets, receipts and invoices.

1.06 Quality Assurance

- a. Regulatory Requirements: Comply with hauling and disposal regulations of authorities having jurisdiction.

PART II – PRODUCTS

PART III – EXECUTION

3.01 Plan Implementation

- a. General: Implement approved waste management plan. Provide handling, containers, storage, signage, transportation and other items as required to implement waste management plan during the entire duration of the Contract.
 1. Comply with operation, termination and removal requirements in CSI Section 01 50 00, Construction Facilities and Temporary Controls.
- b. Training: Train workers, subcontractors and suppliers on proper waste management procedures, as appropriate for the Work occurring at the Project sites.
- c. Site Access and Temporary Controls: Conduct waste management operations to ensure minimum interference with roads, streets, walks, walkways, plant structures and equipment and other adjacent occupied and used facilities.
 2. Comply with CSI Section 01 50 00, Construction Facilities and Temporary Controls for controlling dust and dirt, environmental protection and noise control.

3.02 Salvaging Demolition Waste

- a. Salvaged Items for Sale: Not permitted on Project sites.
- b. Salvaged Items for Owner's Use: Salvage Items for Owner's use and handle as follows:
 1. Clean salvaged items.
 2. Pack or crate items after cleaning. Identify contents of containers with label indicating elements, date of removal, quantity and location where removed.
 3. Store items in a secure area until delivery to Owner.
 4. Transport items to Owner's storage area designated by Owner
 5. Protect items from damage during transport and storage.
- c. Equipment: Drain tanks, piping and fixtures. Seal openings with caps or plugs; caps and/or plugs shall be sealed in a manner to prevent vandalism. Protect equipment from exposure to weather.

3.03 Recycling Demolition Waste, General

- a. Recycling Incentives: Revenues, savings, rebates, tax credits and other incentives received for recycling waste materials shall accrue to Contractor.

- b. Preparation of Waste: Prepare and maintain recyclable waste materials according to recycling or reuse facility requirements. Maintain materials free of dirt, adhesives, solvents, petroleum contamination and other substances deleterious to the recycling process.
- c. Procedures: Separate recyclable waste from other waste materials, trash and debris. Separate recyclable waste by type at Project sites to the maximum extent practical according to approved construction waste management plan.
 - 1. Provide appropriately marked containers or bins for controlling recyclable waste until removed from Project sites. Include list of acceptable and unacceptable materials at each container and bin.
 - a. Inspect containers and bins for contamination and remove contaminated materials if found.
 - 2. Stockpile processed materials on-site without intermixing with other materials. Place, grade and shape stockpiles to drain surface water. Cover to prevent windblown dust.
 - 3. Stockpile materials away from construction areas. Do not store within drip line of remaining trees.
 - 4. Store components off the ground and protect from the weather.
 - 5. Remove recyclable waste from Owner's property and transport to recycling receiver or processor.

3.04 Disposal of Waste

- a. General: Except for items or materials to be salvaged, recycled or otherwise reused, remove waste materials from Project sites and legally dispose of them in a landfill or incinerator acceptable to authorizes having jurisdiction.
 - 1. Except as otherwise specified, do not allow waste materials that are to be disposed of accumulate on-site.
 - 2. Remove and transport debris in a manner that will prevent spillage on adjustment surfaces and areas.
- b. Burning: Do not burn waste materials.
- c. Disposal: Remove waste materials from Owner's property and legally dispose of them.

END OF SECTION

SECTION 01 78 00 CLOSEOUT SUBMITTALS AND REQUIREMENTS

PART I – GENERAL

1.01 Description

- a. Work Included: Provide an orderly and efficient transfer of the completed Work to NOR.
- b. Related Work:
 - (1) Documents affecting work of this section include, but are not necessarily limited to, General Conditions, Supplementary Conditions, and Sections in the Divisions of these Specifications.
 - (2) Activities relative to Contract Closeout are described in, but not necessarily limited to, Items 1.14, 1.40, 1.41, 1.45, 1.56, 1.65, 1.68, 1.69 and 1.70 of the General Conditions of this Contract.

1.02 Quality Assurance

- a. Prior to requesting inspection by NOR, use adequate means to assure that the Work is completed in accordance with the specified requirements and is ready for the requested inspection.

1.03 Procedures

- a. Substantial Completion:
 - (1) Notify NOR of readiness for inspection described by Item 1.68a of the General Conditions of the Contract.
 - (2) Within a reasonable time after the Contractor's notice, NOR will inspect the project and prepare a correction list.
 - (3) Should NOR determine that the Project is not substantially complete:
 - A. NOR will promptly notify the Contractor, in writing, giving the reasons therefore in accordance with Item 1.68b of the General Conditions of the Contract.
 - B. The Contractor shall remedy the deficiencies and notify NOR when ready for reinspection.
- b. Final Completion: When all Work is complete, NOR will prepare a "Notice of Completion" as defined in Item 1.73, also in accordance with Item 1.69 of the General Conditions of the Contract.
- c. Project Closeout – Provide the following to complete the Work of this Project:
 - Project Record Documents described in Section 01 78 39 and Items 1.40 and 1.41 of the General Conditions of the Contract.
 - (1) Warranties and bonds.
 - (2) Keys and keying schedule.
 - (3) Spare parts and materials extra stock.

- (4) Evidence of compliance with requirements of governmental agencies having jurisdiction including, but not necessarily limited to:
 - A. Certificates of Inspection.
 - B. Certificates of Occupancy.
- (5) Lien releases.
- (6) List of subcontractors, service organizations and principal vendors, including names, addresses, and telephone numbers where they can be reached for emergency service at all times including nights, weekends and holidays.

1.04 Instruction

- a. Instruct NOR's personnel in proper operation and maintenance of systems, equipment and similar items which were provided as part of the Work.

END OF SECTION

SECTION 01 78 23 OPERATION AND MAINTENANCE DATA

PART I - GENERAL

1.01 Description

- a. Work Included: To aid the continued operation and maintenance and to provide a positive source of information regarding the products incorporated into the Work, furnish and deliver the data described in this section and in pertinent other sections of these Specifications.
- b. Related Work:
 - (1) Documents affecting work of this section include, but are not necessarily limited to, General Conditions, Supplementary Conditions, and sections in Division 1 of these Specifications.
 - (2) Required contents of submittals also may be amplified in pertinent other sections of these Specifications.

1.02 Quality Assurance

- a. In preparing data required by this section, use only personnel who are thoroughly trained and experienced in operation and maintenance of the described items, completely familiar with the requirements of this section, and skilled in technical writing to the extent needed for communicating the essential data.

1.03 Submittals

- a. Comply with pertinent provisions of Section 01 25 00.
- b. Submit a copy of a preliminary draft of the proposed manual(s) to NOR for review and comments.
- c. Unless otherwise directed in other sections or in writing by NOR, submit two copies of the final manual to NOR prior to training of operation and maintenance personnel.

PART II - PRODUCTS

2.01 Instruction Manuals

- a. Where instruction manuals are required to be submitted under other sections of these Specifications, prepare in accordance with the provisions of this section.
- b. Format:
 - (1) Size – 8 ½" x 11".
 - (2) Paper – White bond, at least 20-lb. weight.
 - (3) Text – Neatly written or printed.

- (4) Drawings – 11" in height preferable; bind in with text; foldout acceptable; larger drawings acceptable by fold to fit within the manual and provide a drawing pocket inside rear cover or bind in with text.
 - (5) Fly Sheets – Separate each portion of the manual with neatly prepared fly sheets briefly describing contents of the ensuing portion; fly sheets may be in color.
 - (6) Binding – Use heavy-duty plastic or fiberboard covers with binding mechanism concealed inside the manual; 3 ring binders will be acceptable.
 - (7) Measurements – Provide all measurements in U.S. standard units such as feet and inches, pounds, etc.
- c. On or through the front cover and spine of each manual clearly identify the project. At least the following information should be provided:

OPERATION AND MAINTENANCE INSTRUCTIONS

Name and Address of Work

Name of Contractor

General Subject of the Manual

Space for Approval Signature of NOR

Approval Date

- d. Contents – include at least the following:
- (1) Neatly typewritten index near the front of the manual giving immediate information as to location within the manual of all emergency information regarding the installation.
 - (2) Complete instructions regarding operation and maintenance of all equipment involved including lubrication, disassembly and reassembly.
 - (3) Complete nomenclature of all equipment parts.
 - (4) Complete nomenclature and part number of all replaceable parts, name and address of nearest vendor, and all other data pertinent to procurement procedures.
 - (5) Copy of all guarantees and warranties issued.
 - (6) Manufacturers' bulletins, cuts and descriptive data where pertinent, clearly indicating the precise items included in this installation and deleting or clearly indicating all manufacturers' data that is not pertinent to this installation.

PART III - EXECUTION

3.01 Instruction Manuals

- a. Preliminary:
- (1) Prepare a draft of each proposed manual.
 - (2) Show general arrangement, nature of contents, probable number of drawings and their size, and proposed method of binding and covering.

- (3) Secure NOR's approval prior to proceeding.
- b. Final: Complete the manuals in strict accordance with the approved preliminary drafts and NOR's review comments.

END OF SECTION

SECTION 01 78 39 PROJECT RECORD DOCUMENTS

PART I – GENERAL

1.01 Description

a. Work Included:

- (1) Throughout the progress of the Work, maintain an accurate record of changes in the Contract Documents, as described in Article 3.01 below.
- (2) Upon completion of the Work, transfer the recorded changes to a set of Record Documents, as described in Article 3.02 below.

b. Related Work:

- (1) Documents affecting work of this section include, but are not necessarily limited to, General Conditions, Supplementary Conditions, and Sections in Division 1 of these Specifications.
- (2) Other requirements affecting Project Record Documents may appear in pertinent other sections of these Specifications.

1.02 Quality Assurance

a. Accuracy of Records:

- (1) Thoroughly coordinate changes within the Record Documents, making adequate and proper entries on each page of Specifications and each sheet of Drawings and other Documents where such entry is required to show the change properly.
- (2) Accuracy of records shall be such that future search for items shown in the Contract Documents may rely reasonably on information obtained from the approved Project Record Documents.

b. Make entries within 24 hours after receipt of information that the change has occurred.

1.03 Product Handling

a. Maintain the job set of Record Documents completely protected from deterioration and from loss and damage until completion of the Work and transfer of all recorded data to the final Project Record Documents.

b. In the event of loss of recorded data, use means necessary to again secure the data to NOR's approval.

- (1) Such means shall include, if necessary in the opinion of NOR, removal and replacement of concealing materials.
- (2) In such case, provide replacements to the standards originally required by the Contract Documents.

PART II - PRODUCTS

2.01 Record Documents

- a. Job Set: Promptly following receipt of the Owner's Notice to Proceed, secure from NOR at no charge to the Contractor one complete set of all Documents comprising the Contract.
- b. Final Record Documents: At a time nearing the completion of the Work, secure from NOR at no charge to the Contractor one complete set of sepia transparencies of all Drawings in the Contract to be prepared as the reproducible "as built" drawings.

PART III - EXECUTION

3.01 Maintenance of Job Set

- a. Immediately upon receipt of the job set described in Paragraph 2.01-a above, identify each of the Documents with the title, "Record Documents-Job Set."
- b. Preservation:
 - (1) Considering the Contract completion time, the probable number of occasions upon which the job set must be taken out for new entries and for examination, and the conditions under which these activities will be performed, devise a suitable method for protecting the job set to the approval of NOR.
 - (2) Do not use the job set for any purpose except entry of new data and for review by NOR, until start of transfer of data to final Project Record Documents.
- c. Making entries on Drawings:
 - (1) Using an erasable colored pencil (not ink or indelible pencil), clearly describe the change by graphic line and note as required.
 - (2) Date all entries.
 - (3) Call attention to the entry by a "cloud" drawn around the area or areas affected.
 - (4) In the event of overlapping changes, use different colors for the overlapping changes.
- d. Make entries on all pertinent Documents.
- e. Conversion of Schematic Layouts:
 - (1) In some cases on the Drawings, arrangement of conduits, circuits, piping, ducts, and similar items are shown schematically and are not intended to portray precise physical layout.
 - A. Final physical arrangement is determined by the Contractor, subject to NOR's approval.
 - B. However, design of future modifications of the facility may require accurate information as to the final physical layout of items which are shown only schematically on the Drawings.
 - (2) Show on the job set of Record Drawings, by dimension accurate to within one inch, the centerline of each run of items such as are described in subparagraph 3.01-e-1 above.

- A. Clearly identify the item by accurate note such as "cast iron drain," "galv. water," and the like.
 - B. Show, by symbol or note, the vertical location of the item ("under slab," "in ceiling plenum," "exposed," and the like).
 - C. Make all identification sufficiently descriptive that it may be related reliably to the Specifications.
- (3) NOR may waive the requirements for conversion of schematic layouts where, in NOR's judgment, conversion serves no useful purpose. However, do not rely upon waivers being issued except as specifically issued in writing by NOR.

3.02 Final Project Record Documents

- a. The purpose of the final Project Record Documents is to provide factual information regarding all aspects of the Work, both concealed and visible, to enable future modification of the Work to proceed without lengthy and expensive site measurement, investigation and examination.
- b. Approval of recorded data prior to transfer:
 - (1) Following receipt of the transparencies described in Paragraph 2.01-b above, and prior to start of transfer of recorded data thereto, secure NOR's approval of all recorded data.
 - (2) Make required revisions.
- c. Transfer of data to Drawings:
 - (1) Carefully transfer change data shown on the job set of Record Drawings to the corresponding transparencies, coordinating the changes as required.
 - (2) Clearly indicate at each affected detail and Drawing a full description of changes made during construction, and the actual location of items described in subparagraph 3.01-e-1 above.
 - (3) Call attention to each entry by drawing a "cloud" around the area or areas affected.
 - (4) Make changes neatly, consistently, and with the proper media to assure longevity and clear reproduction.
- d. Transfer of data to other Documents:
 - (1) If the Documents, excluding Drawings, are kept clean during progress of the Work, and if entries thereon are approved by NOR and neatly noted, the job set of such Documents may be accepted as final Record Documents.
 - (2) If such Documents are not acceptable to NOR, secure new copies from NOR and carefully transfer the changed data to the new copy to the satisfaction of NOR.
- e. Review and Submittal:
 - (1) Submit the completed set of Project Record Documents to NOR as described in Paragraph 1.03-d above.

- (2) Participate in review meetings as required.
- (3) Make required changes and promptly deliver the final Project Record Documents to NOR.

3.03 Changes Subsequent to Acceptance

- a. The Contractor has no responsibility for recording changes in the Work subsequent to Final Completion, except for changes resulting from work performed under Warranty.

END OF SECTION



Division 09 00 00
Finishes

Installation Instructions

Luxury Vinyl Tile & Plank - Glue Down

2TWELVE, 3TWENTY, VOYAGER & TIMES SQUARE



CERTIFIED BY
SCS Global Services



Attention

Before starting installation, read all instructions thoroughly. Should any questions arise, please contact your local Hallmark Floors dealer or phone Hallmark Floors direct at 888 551 0888. Instructions are available at www.hallmarkfloors.com. Instructions are also available via cell phone. All installation instructions must be followed for warranties to be considered valid. Pre-inspect the job site prior to delivery of the floor to ensure the structure is suitable for luxury vinyl flooring installation using the following guidelines

Owner/Installer Responsibility

1. Inspect all materials carefully prior to installation. Warranties do not cover materials with visible defects once they are installed. Installation constitutes acceptance.
2. Inspect the luxury vinyl flooring in well lighted conditions to ensure proper identification of any potential problems. Carefully inspect the flooring for grade, color, finish, and quality. If the flooring is not acceptable, contact Hallmark Floors' distributor and arrange shipment of replacement material. Defective product will be replaced. Material that is subjectively viewed as unacceptable but falls within Hallmark Floors' grading norms will not be replaced.
3. Prior to installation of any flooring, the installer must ensure the job site and sub floor conditions meet the requirements specified in these instructions.
4. Luxury vinyl flooring installation should be one of the last items completed on the construction project. Limit foot traffic on the finished luxury vinyl plank/tile.

Storage & Handling

Handle and unload luxury vinyl flooring with care. Store in a dry place. Make sure to provide at least a 4" space (a dry pallet with a solid plywood top that provides enough clearance under boxes for proper air movement). Prior to delivery of flooring, outside doors and windows must be in place. All concrete, masonry, plastering, and other "wet" work must be complete and thoroughly dry. Roofing and the exterior shell of the structure must be finished and weather tight with doors and windows installed. The wall coverings should be in place and all painting completed—except for the final coat on the base molding. Room temperature and humidity should be consistent with year-round conditions for at least one week prior to installation. When possible, install base molding after floor installation is complete. Flooring should be stored and installed in climate constant or climate controlled indoor location 65°F TO 85°F and between 30 to 50% relative humidity. Product and adhesives must be acclimated to a living condition environment for 48 hours prior to installation.

***ATTENTION:** Exposure to sunlight and other heat sources may affect the performance and installation of the floor.

Pre-Installation Inspection Visual Inspection

The first inspection is visual and basic. Is there visible moisture present? Are there uncovered South/West facing windows or sliding glass doors?

Climate Control

If heating and/or air conditioning with proper humidity controls are in operating condition, they need to be turned on. If it is not possible for the permanent system to operate, a temporary system that provides proper temperature and humidity conditions must be in place and remain in place until permanent climate and humidity control is operational. Temperature of 65°-85°F must be maintained.

Install Flooring Last

Luxury vinyl should be the last trade in the house (before base boards are installed). All concrete, masonry, plastering/drywall, texturing, and painting primer coats are completed. Do not install in direct sunlight.

Covering the floor while wet trades are in the house is not recommended. Moisture can pull into the paper or be trapped under the surface of materials used to cover the floor. Paper coverings also allow dents and scratching to occur. Coverings held in place for more than 24 hours by blue tape can damage the floor.

Hallmark Floors recommends that built-in cabinets and built-in furniture be installed before installation of the floor. This prevents damage to the flooring and makes potential flooring repairs simpler to perform.

Exterior Checks

1. Is exterior soil elevation 6" below edge of flashing?
2. Does exterior slope away from foundation at a rate of 6" drop in 10' for soft-landscaped areas and 3" drop in 10' for hard-paved areas?

NOTE: Proper drainage away from the structure is absolutely critical to ensure weather-tight conditions and crucial to proper luxury vinyl flooring performance.

If structure is near a hill, the lot should be graded with a swale to move moisture off the lot and prevent it from coming in contact with the foundation.

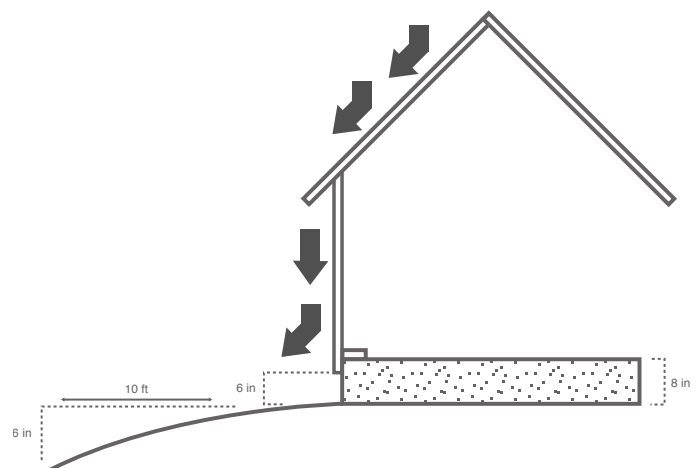

Crawl Space Ventilation

Crawl space earth (or thin concrete slab) should be covered 100% by a vapor retarder of black polyethylene (minimum 6 mil) or any recommended puncture-resistant membrane, such as Class C meeting ASTM D1745. Check local codes for any additional requirements.

Size of available vents should equal to 1.5% of the square footage within the crawl space. Relative humidity should be consistent with interior of home. Moisture content of sub floor should not vary more than a 2% MC from the top of the sub floor to the bottom.

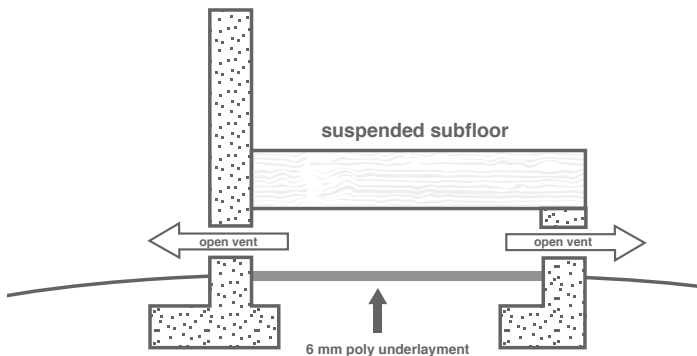

It may be necessary to install temperature/humidity activated exhaust fans to create more air movement in the crawl space. Uncontrolled humidity and moisture in crawl space will lead to mold and damage to the structure, as well as the luxury vinyl floor. In these events, a contractor specializing in dehumidifying systems will need to be contracted to keep crawlspace humidity within proper norms. This is more likely in high humidity areas. Ensure that clothes driers are properly vented to the outside of the foundation. Check for signs of plumbing, both pressurized and non-pressurized/drain leaks.



NOTE: Completely sealed crawlspaces (no exterior cross-ventilation) require a dehumidification system as part of the sealed crawlspace design.

Basement Moisture & Humidity Control

Basements should be completely weather tight and have proper drainage away from the foundation walls in place to ensure that the basement remains dry.

1. Rain gutters must be in place to carry moisture away from the house. French drains are recommended, and basement walls should be properly sealed.
2. Relative humidity of basements should not be more than 10% higher than the upper floors.
3. Humidity control of the basement is vital to help control mold and prevent damage to the structure and luxury vinyl flooring.
4. Basement walls should be inspected for cracks and excessive moisture content.
5. Drains must be placed at basement windows.
6. Direct sprinklers and irrigation systems away from the foundation. Sprinklers spraying the foundation edge can lead to moisture intrusion into structure. Drip irrigation systems for plant beds is recommended.

Sub floor Moisture Testing CONCRETE

ROLLER APPLICATION: Up to 18 lbs. on a Calcium Chloride Test and up to 97% RH (In-Situ Probe).

Up to 25 lbs. on Calcium Chloride.

Test and up to 100% RH (In-Situ Probe).

Hallmark Floors does not offer a moisture warranty against moisture related issues or related damage under warranty, unless our system is used. (See Hallmark Floors Maintenance & Warranty Guides).

NOTE: Due to the porous nature of concrete, vapor emissions are subject to change over the lifetime of the installed floor. Slab moisture emissions are a common cause of damage to vinyl floors. Due to the potential for concrete moisture emissions to increase/decrease over time, and the absence of moisture warranties for vinyl flooring, using an adhesive manufacturer moisture abatement system following NWFA standards. Some adhesive manufacturers offer adhesive/moisture abatement systems that do not require pre-installation testing of the slab to maintain a moisture warranty. Check with adhesive manufacturer to confirm they offer products that allow installation without pre-checking/testing the slab.

ADDITIONAL NOTE: Hallmark Floors makes no guarantees regarding the performance of any adhesive/vapor abatement system.

The installer is fully responsible for proper installation, and the moisture warranties are fully the responsibility of the adhesive moisture abatement system manufacturer chosen for the job.

Industry Standards

Industry standards use the following test methods to determine optimal conditions for installation and performance of a hardwood floor. Some adhesive manufacturers offer systems that create a vapor barrier to protect the luxury vinyl and premium vinyl flooring from moisture emissions coming up through the slab. Many adhesive manufacturers require the below listed tests to be performed prior to installation of the floor: Carefully read and follow the adhesive manufacturers instructions.

CALCIUM CHLORIDE: ASTM F1869

Under ideal conditions, the slab should not be emitting more than 3 lbs. per 1,000 square feet per 24 hour period. Carefully follow the instructions in the test kit to ensure that you get accurate results.

NOTE: The slab emissions can vary based on soil humidity and room temperature. Consult adhesive manufacturer's directions for the moisture abatement system they recommend.

HUMIDITY PROBE & DIGITAL METER: ASTM F2170

Widely used in Europe, this test determines the amount of humidity in the slab. This is an effective way to determine a slab's potential for emitting moisture. Follow all meter manufacturer's guidelines for performing testing. Under ideal conditions, the slab readings should be 75% RH.

CAUTION: Post Tension slabs require special care to avoid cutting cables in slab. Cutting post tension cables can cause serious structural damage and potential fatalities.

New concrete slabs require a minimum of 60 days drying time before covering them with a luxury vinyl or premium vinyl floor. The slab must be fully cured. Slab must be comprised of Portland-based mix with 2,500 PSI of compressive strength.

Sub floor Preparation CONCRETE

For glue down application over gypsum or lightweight concrete, the same 2,500 PSI rating is required.

Note: Some adhesive systems have primers and adhesives that are suitable for use over gypcrete or lightweight concrete, and may have different PSI compressive strength requirements.

Adhesive manufacturer is responsible for performance of their systems over gypcrete or lightweight concrete.

Remove all paint, oil, existing adhesives, wax, grease, dirt, sealers, and curing compounds. Do not use solvent-based strippers under any circumstances because residual solvents can prevent the satisfactory bonding of the vapor barrier and adhesive systems. It is important to ensure a long lasting bond between the adhesive, the concrete, and the boards.

All sub floors must be clean, smooth, and flat within 3/16" in a 10' radius or 1/8" within a 6' radius. Dust, scale, old adhesive, and asphalt cut-back adhesive must be removed.

CAUTION: Test cut-back adhesives for asbestos content. If the cut-back contains asbestos, contact an asbestos abatement company for professional removal.

The surface must be free of paint, grease, drywall, curing/sealing compounds, existing resilient floors, engineered hardwood floors, wax, oil, alkali and any other foreign material that would negatively affect the bonding of the adhesive.

Use sanding system with 20 grit # 3-1/2 open-face paper to remove loose, flaky concrete. For heavy surface contamination, it may be necessary to bead-blast the concrete surface.

Sub floor tolerance for a flat surface is 3/16" within a 10' radius and 1/8" in a 6' radius. These are widely accepted industry standards. Use a straight edge to determine if sub floor requires grinding or filling.

Surface of the concrete floor should be similar to light broom finished concrete before proceeding with installation.

All sub floor patching and leveling should be done with a quality, water resistant, non-shrinking Portland cement patch. Concrete floor must be smooth and flat to prevent telegraphing imperfections in the concrete. NOTE: Be sure to use Portland based patch and levelers on Portland based slabs and Gypsum for Gypcrete. Follow all manufacturer's guidelines for those products.

Wear appropriate NIOSH designated dust mask to reduce risk of dust inhalation. Wear proper eye protection and avoid prolonged contact with eyes and skin. In the event of eye irritation flush with water for 15 minutes and seek medical attention!

Hallmark Floors is not responsible for any movement in expansion joints in concrete slab, nor any performance issues related to the sub floor.

CAUTION: ASBESTOS

State and Federal agencies have determined that asbestos is a respiratory carcinogen. Avoid sanding or scraping of old vinyl, linoleum, and VCT as they may contain asbestos. Take proper precautions and contact an asbestos abatement company to remove any old vinyl or vinyl tile floors containing asbestos. Cut-Back adhesive and other types of adhesives can also contain asbestos.

Do not sand, sweep, dry or wet scrape, mechanically chip, bead blast, or pulverize existing resilient flooring, the felt, lining, paint, black asphalt cutback adhesives, or other existing adhesives. These products could contain asbestos fibers or crystalline silica.

Breathing dust from these sources increases your risk of cancer and respiratory diseases. If you smoke and are exposed to asbestos fibers, you are at greater risk of serious damage to your health.

If you are not sure that the product being removed is asbestos free, assume that the product contains asbestos or crystalline silica. Regulations in your area may require you to have the material tested to determine if it contains asbestos. Check the Resilient Floor Coverings Institutes' recommendations for removal of existing resilient floor coverings.

Chemical adhesive removal products must not be used to prepare the slab. Use of such chemicals will void the warranty on all Hallmark Floors products

Installing over Existing Floor Coverings on Concrete

Perimeter-glued resilient vinyl, VCT and rubber tiles are not acceptable underlayments and must be removed.

Sub floor Moisture Testing wood

Probe-type (pin) meters are considered the best method of testing. Remember: the top and bottom of the sub floor should vary no more than 2%. Wood substrates must have a moisture reading of no more than 12% when using Lignomat, Tramax, Delmhorst, or equivalent moisture meter, and be within 4% of the moisture content of the flooring to be installed.

Sub floor Preparation WOOD

1. Wood sub floors with a crawlspace must have a minimum of 18" between the bottom of the joists and the surface of the soil. Soil must be covered with 6-8 mil black plastic as vapor barrier. Plastic must be overlapped at joints by a minimum of 8 inches and fully taped with a high quality moisture-proof duct tape.
2. All sub floors must be clean, smooth and flat within 3/16" in a 10' radius and 1/8" in a 6' radius. Dust, scale, old adhesive, and asphalt cut-back adhesive must be removed. The surface must be free of paint, grease, drywall, curing/sealing compounds, existing resilient floors, engineered hardwood floors, wax, oil, alkali, and any other foreign material that would negatively affect the bonding of the adhesive. CAUTION: Test cut-back adhesives for asbestos content. If the cut-back contains asbestos, contact an asbestos abatement company for professional removal.
3. Solid Board Sub flooring should be 3/4" x 5 1/2" (1" x 6") group 1 dense softwoods (SYP, Doug Fir, Larch, etc.), #2 common, kiln-dried. Solid board sub flooring should consist of boards no wider than 6", installed on a 45° angle, with all boards ends full bearing on the joists and fastened with a minimum 8d rosin-coated or ring-shanked nails, or equivalent. Solid board sub flooring that is uneven at edges should be repaired and sheeted with 1/2" (15/32", 14 mm) Baltic Birch 1 plywood sub floor panels, 4' x 8' sheets, and should be installed running cross-truss/joist. Glue top and bottom layer together with construction adhesive and screw into the truss/joist system every 12". Additionally nail (ring shank) or staple layers together on a minimum 12" grid pattern.

4. Plywood/OSB Sub floors

- a. Truss/joist spacing of 16" (406cm) o/c or less, the industry standard for single panel sub flooring is a minimum of 5/8" (19/32", 15.1mm) CD Exposure 1 plywood sub floor panels or 23/32" OSB Exposure 1 sub floor panels, 4' x 8' panels. Place 6-9mm Baltic Birch plywood on surface.
- b. Truss/joist spacing of more than 16", up to 19.2" (488mm) o/c, the standard is a minimum 3/4" (23/32", 18.3mm) tongue and groove CD Exposure 1 plywood 4' x 8' sheets glued and mechanically fastened. Place 6-9mm Baltic Birch plywood on surface.
- c. Truss/joist spacing of more than 19.2" (488mm) o/c up to a maximum of 24" (610mm) o/c requires a minimum 7/8" tongue and groove CD Exposure 1 plywood sub floor panels, 4' x 8' sheets, glued and mechanically fastened, or nominal 1" OSB Exposure 1 sub floor panels glued and mechanically fastened –or two layers of sub flooring. Place 6-9mm Baltic Birch plywood on surface.

5. Joist Cross-Bracing

A sub floor that is not thick enough to support the span of the joists will cause unacceptable sub floor deflection. An alternative to adding additional plywood on top of the sub floor would be to cross-brace between the joists. The cross-bracing would be done at the appropriate distance on center to meet specification and bring the deflection within proper tolerance.

Check with the joist or truss manufacturer to determine if cross-bracing is allowed with that system. Should it not be compatible with the joist or truss manufacturer, sheeting the sub floor with a second layer of 9mm/ 3/8" Baltic Birch plywood would then be the only option.

DIRECTION OF INSTALLATION IN RELATION TO JOIST DIRECTION.

The best application is at a 90° angle across the joists. This provides for best stability of the floor. As an alternative, the floor can be installed at a 45° angle to the joists. The floor cannot be installed in the same direction as the joists without installing an additional sheet of plywood on top of the existing wood sub floor.

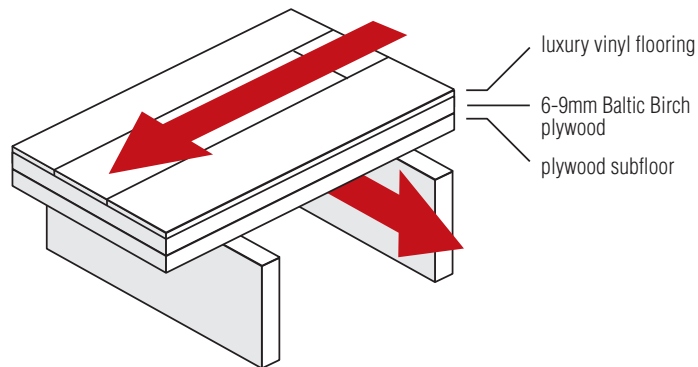

6. For Glue Down Application Sheet wood sub floor with minimum 6mm Baltic Birch Underlayment Plywood. Use 9mm if sub floor needs additional rigidity. Hallmark Floors does not warrant our products glued down to subfloor-grade plywood, particle board, O.S.B, Luan or Maranti types of underlayment.

6mm Plywood Underlayment Crossection



9mm Plywood Underlayment Crossection

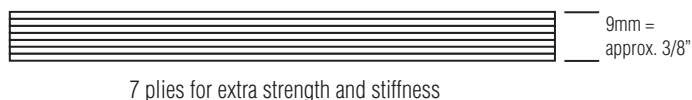

7. Make any repairs necessary to the existing sub floor prior to installing Baltic Birch plywood underlayment. CAUTION: Some nail types, i.e. common steel nails, can cause discoloration of the vinyl floor. Gluing down with construction adhesive and screwing plywood panels into joists can cause discoloration issues. Solvent-based construction adhesives can stain vinyl floor covering. Use of solvent free construction adhesives is therefore recommended to avoid floor stain issues. Hallmark Floors, is not responsible for discoloration of vinyl floor from adhesives used to secure Baltic Birch plywood underlayment to sub floor.

8. See Baltic Birch plywood underlayment manufacturer's specification/instructions for proper installation of product.
9. Stagger Baltic Birch plywood end joints and loosely butt edges per installation panel manufacturers installation instructions. Fastener holes and seams should be filled with a polymer modified patch. These products are applied in a thin skim coat per manufacturers instructions. Make sure to fill all end and side joint nail holes and dents in the underlayment to prevent transfer to the surface. Allow to dry completely.
Note: Remember, the patch may be ¼" deep or more in the joint between two panel edges. Not that it will not dry as quickly as a surface patch. When a latex adhesive is applied to the underlayment, some of the water is absorbed into the wood causing it to expand slightly. This expansion will force the wet patch out of the joint, forming a bead that can be seen through the vinyl.

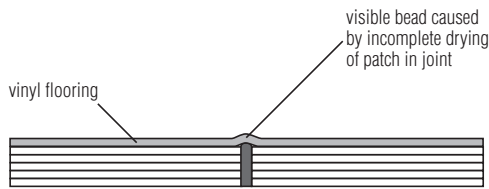

10. Lightly butt Baltic Birch plywood underlayment panel edges together. Do not force panels together, but do not leave a gap. Leave a minimum perimeter gap of ¼" and a maximum gap of ½" between the Baltic Birch plywood underlayment panel edges and the walls for expansion.
11. Cut Baltic Birch plywood underlayment panels as necessary and lay out factory edges to factory edges. Lay out any edges with jobsite cuts towards the wall. Make any long, straight cuts from the underside of the Baltic Birch plywood underlayment panel using a circular power saw with a fine toothed blade. Adjust the blade to extend no more than 3/8" through the Baltic Birch plywood underlayment to minimize splintering.

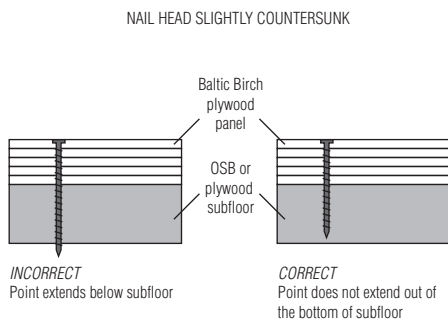

12. Selecting the Baltic Birch plywood underlayment fasteners:
Use plated ring shank underlayment nails with a 3/16" diameter head or double coated chisel point staples with a ¼" maximum crown. The fastener length should be selected so that the point will not extend through the bottom side of the sub floor. Do not use uncoated, cement coated, or rosin coated fasteners, as they may contribute to staining/discoloration. Ensure the panel is in firm contact with the sub floor. Always have your body weight on the panel being fastened.

13. All fasteners should be countersunk slightly below the surface of the new underlayment. Adjust air pressure on air staplers to a minimum to avoid staple blow through. Fill with feather patch approved for such use, allow to dry, and sand nail holes and joints to prevent telegraphing through surface of vinyl. Avoid over-sanding and cupping of joints.
14. Once the patch is dry, re-sand all areas with a low-speed rotary sander. If necessary, patch again, allow to dry, and re-sand with a low-speed rotary sander. Keep the underlayment clean and dry until luxury the vinyl flooring is ready to be installed. If necessary, cover Baltic Birch plywood underlayment with protective paper until ready to install luxury vinyl flooring.

Clean the Sub floor

After all prep work is completed, sweep and/or vacuum the sub floor. Dust and dirt can affect the adhesive's ability to adhere to the sub floor.



Other Substrates QUARRY TILE, TERRAZZO AND CERAMIC TILE.

Any embossing or grout joints need to be filled with a Portland-based cementitious patch. Substrates must be firmly attached to sub floor. Hallmark Floors makes no warranties in regards to performance or suitability of use of any sub floor or substrate. The surface must be sound, tight, and free of paint, oil, existing adhesives, wax, grease, and dirt.

Terrazzo and ceramic tile must be sufficiently scuffed to assure adhesion. Portland based cementitious levelers must be used to comply with flatness requirements of 3/16" in a 10' radius or 1/8" in a 6' radius. See adhesive/cementitious levelers manufacturer's guidelines.

Existing vinyl, tile, or terrazzo are not considered to be vapor barriers and can still transmit unacceptable moisture levels which can become trapped under a vinyl floor. This is true of both concrete and wood sub floors. Wood fibers, dust, drywall, latex paint, or other organic material under the floor can promote fungal growth, degradation of adhesives, and dimensional instability in the plank/tile. Therefore, preventing excessive moisture under the floor is critical.

Existing hardwood flooring must be remove prior to installation.

Luxury Vinyl Radiant Heat

All Radiant Heat systems must have failsafe capability to ensure surface temperatures do not exceed 80°F.

Lightweight Concrete/Gypcrete

1. The heating system tubes must be 1 ½" below the surface layer of the concrete slab/thermal mass.
2. 2-3 weeks prior to the installation the thermostat must be set at 70° F, then at 85°F for 3 days. The home should be aired out briefly every day to allow the excess humidity from the thermal mass to exhaust out of the structure.
3. The lightweight concrete moisture content must not exceed 1.5% as measured with a Tramax Moisture Encounter meter prior to installation.
4. Lightweight concrete/gypsum based thermal mass must have a minimum compressive strength of 2,500 psi. When gluing down see adhesive, see manufacturer's recommendations for compressive strength.

Wood Sub floor Systems With Aluminum Transfer Components

5. ALUMINUM HANGERS

Aluminum hangers must be .03125"/0.79mm to .0625"/1.58mm thick and have a minimum of ¾" sub floor. Hangers must reach joist to joist 16" to 19.2" on center, and have no gaps between sides and ends of aluminum hangers. A good system also contains insulation to prevent thermal loss and ensure even heating.

6. DECKING OVER SLEEPERS

Decking must be a minimum of ¾" thick with a minimum ¾" sub floor with an aluminum transfer sheet of .03125"/0.79mm to .0625"/1.58mm in thickness and attached to the bottom of the decking material. Sleepers should be 18" on center. In-floor heating systems must be water-based, low temperature, and must be designed to prevent surface temperature of the floor from exceeding 80° F. All glue down applications on wood sub floor assemblies must be sheeted with at least 6mm Baltic Birch plywood and prepped as described in these instructions.

7. No electric radiant heat systems are approved for use with Hallmark Floors 3Twenty, 2Twelve, Voayger and Times Square luxury vinyl flooring!!!

8. Passive radiant heat systems are not suitable for use with Hallmark Floors luxury vinyl flooring. Any approved radiant system must be combined with the ability to move the air in the room for proper heat distribution and to prevent excessive heat at floor level. Humidity controls must be in place to maintain relative humidity within a 30 to 55% RH range.

9. Surface-channeled radiant boards, are not acceptable for use under Hallmark Floors resilient flooring. A minimum of ¾" must be maintained between the vinyl floor and the water tubing. This is not possible with these types of systems. This applies to systems with or without an aluminum transfer sheet.

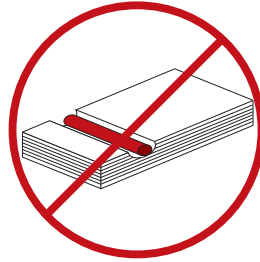

Sub floor level tolerances listed previously, also apply to radiant heated sub floors.

NOTE: Area rugs placed over radiant heat slab will create heat retention in the floor. This may result in that area exceeding optimum temperature, and causing slightly larger gaps and minor distortions to the floor under the rugs.

Below Grade Installation

A concrete slab is considered below grade when any part of the slab is below ground level. For example, a basement with a walk out is considered below grade. A house cut into a hill is also considered to be below grade if it isn't properly graded to create a drainage swale on the lot. Below grade slabs must be carefully tested. Diligently follow all adhesive manufacturer's instructions for below grade installation.

Getting Started

1. Select Installation Type

ABOVE GRADE WOOD SUB FLOOR: Glue (Sheet with Baltic Birch plywood underlayment).

WOOD SUB FLOOR WITH CRAWL SPACE/ BASEMENT: Glue (Sheet with Baltic Birch plywood underlayment).

ON/ABOVE-GRADE CONCRETE: Glue (vapor abatement recommended for on grade installation).

BASEMENT: Glue with vapor abatement system.

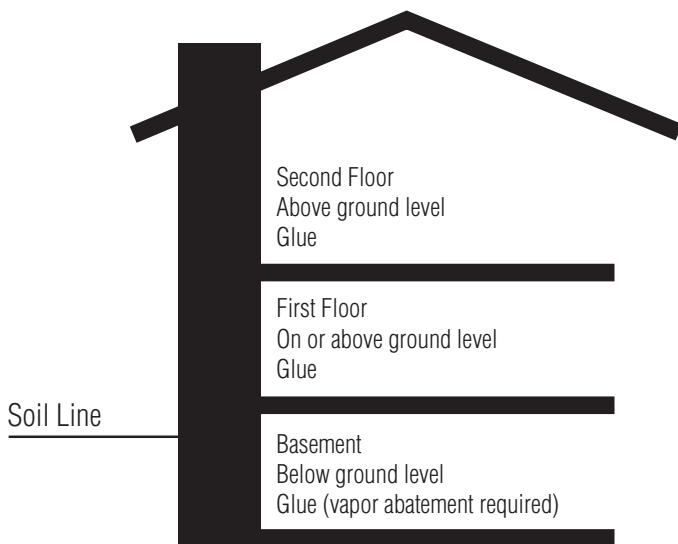

2. Cabinets & Appliances

Cabinets and built in appliances (sub-zero style refrigerators & dishwashers) should be installed prior to the installation of the luxury vinyl floor. Cabinets and built in appliances should not be installed on top of the floor. Installation of cabinets on top of glue down installation does not invalidate warranty. However, since this is not best practice, should the floor require repair under warranty, Hallmark Floors will not be liable for costs to remove and replace cabinets and or counter tops to effect repair. Luxury vinyl flooring should be installed at the same time as carpet and after the following: finishing walls, cabinet installation, appliance installation, tile & counter top installation. Standard refrigerators and kitchen oven/range are acceptable for placement on top of the luxury vinyl floor. Use caution when moving appliances by using a proper furniture dolly, air sled, 1/8" Masonite with glossy side down, or plastic glides designed for movement of heavy appliances. Failure to follow these precautions will damage the floor.

3. Undercut All Door Jambs/Moldings

Remove all shoe and base molding to ensure adequate expansion space. Use scrap piece of flooring to establish height of cut. Make allowances for adhesive or underlayment thickness when establishing height of cut.

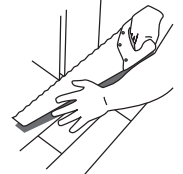

4. Visual Inspection of Planks/Tiles

Visually inspect planks/tiles for any defects prior to installation. Verify that homeowner and/or end user has seen the product and approves proceeding with installation of the floor.



5. Open Multiple Boxes

Always work from multiple boxes simultaneously and blend the planks/tiles throughout the installation. This is especially important with mixed production dates. Hallmark has very good color consistency, and mixed production dates are acceptable for installation. Working from multiple boxes/production dates helps achieve a good blend of color.

6. Blend Boards to Moldings

Before you get started, open multiple boxes and check how the planks/tiles blend with the moldings. At beginning of installation, set aside those planks/tiles that best blend to the transition moldings on job.

7. Select a Starter Wall

When installing luxury vinyl, it is recommended to base the layout of the installation off of an exterior wall. Check to make sure the wall is straight and square to the room.

8. Starting Line

For starting row, cut blocks to use against side and end walls to maintain $\frac{1}{4}$ " minimum expansion space. Use spacers at both side the end of the rows. Use of adjustable spacers may be needed to help maintain a straight line.

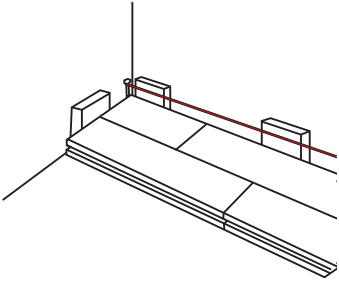

9. Irregular & Out-of-Square Walls

Scribe cut the first row to match variations in the wall. A scribe can be created by drilling a hole in a scrap piece of wood and inserting a pencil. The starting row can then be cut to compensate for an irregular wall or to help minimize the appearance of an out of square room by splitting the difference between the two walls.

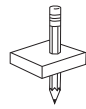

Glue Down Installation - Plank

2MM: PLank & Tile

3MM: Plank & Tile

Before installing any material, plan the layout of the plank end joints to avoid lining up on top of the sub floor/underlayment joints. Do not install plank end joints over expansion joints.

Installation Tools GLUE DOWN PLANK

Tape measure, pencil, chalk line, table saw, cut-off saw, vinyl guillotine, jamb saw, spacers, hammer, safety glasses, hearing protection, utility knife, specified notched trowel, wall spacers, straight edge, broom, speedy square, luxury vinyl floor cleaner, and shop vacuum.

NOTE: Hallmark Floors recommends pattern scribing, with utility knife or cutting with a power miter saw or vinyl guillotine cutter for cutting luxury vinyl plank.

10 GDP. Measure the Room

Accurately measure the room to determine the center line, and total width of the floor. The width can be divided by the width of the plank. This helps establish how many rows are required. The starting row and ending row can then be trimmed so the width of the starting plank and ending plank can be the same. Once this is known the starting row can be ripped to a narrower width if necessary, to give the floor balance.

11 GDP. Establish End Joint Pattern

Plank ends should be staggered, randomly to avoid a cluster or stair stepping of end joints. Varying the length of the starter plank will give the appropriate stagger for that row.

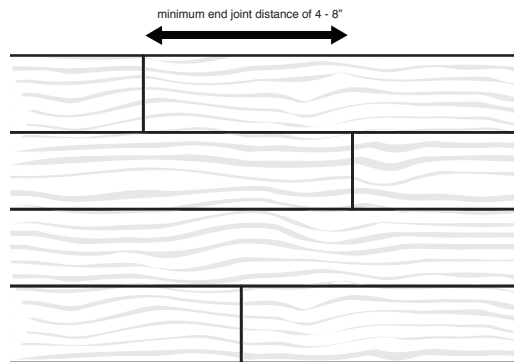

12 GDP. Starter Rows

Measure the equivalent of four to five rows, mark sub floor at both ends of run and snap a chalk line. Spread adhesive to chalk line. Repeat this process on all subsequent rows of material throughout the balance of installation. If starting from a center line, begin laying Hallmark Floors luxury vinyl flooring along the starting line and work back to the starting wall.

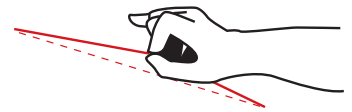
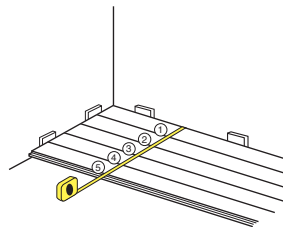

13 GDP. Set Planks

Spread adhesive and set plank into the adhesive while avoiding any movement of the plank. Clean up all adhesive residue from surface of floor as you proceed. Do not allow adhesive to dry on the surface of the planks.

14 GDP. Directional Installation

Ensure the planks are installed with the arrows imprinted on the back of the planks are laying in the same direction. If there are no arrows, the material is non-directional, and can be installed in either direction.

15 GDP. Roll Floor

After completion of the installation, the floor must be rolled with a minimum 100 lb. 3-section floor roller in both directions. Cover steel rollers with fresh duct tape before every use to prevent steel rollers damaging the surface of the floor.

16 GDP. Install Trim/Moldings

Cover all exposed areas. Use appropriate trim pieces along all walls, cabinets, etc. Use appropriate transition pieces in doorways or where Hallmark Floors luxury vinyl meets other flooring.

17 GDP. Clean Up

Remove all glue residue from the floor and vacuum up remaining debris.

Other than glue residue removal and vacuuming, do not clean the floor for 48 hours after installation. After 48 hours, use a damp mop with well-wrung-out sponge mop to remove residue and clean with Hallmark Trueclean.

ATTENTION!: Exposure to direct sunlight and other heat sources may affect the performance of the floor. Temporary paper shades/sheets over windows/glass doors can protect the floor surface from excessive heat and light. This will provide a measure of protection until permanent window coverings can be installed.

Glue Down Installation Tile

3MM: 18"x 18" tile

Before installing any material, plan the layout of the tile end joints to avoid lining up on top of the sub floor/underlayment joints. Do not install tile joints over expansion joints.

Installation Tools GLUE DOWN TILE

Tape measure, pencil, chalk line, table saw, vinyl guillotine, jamb saw, spacers, hammer, safety glasses, hearing protection, utility knife, specified notched trowel, wall spacers, straight edge, broom, speedy square, luxury vinyl floor cleaner, and shop vacuum.

NOTE: Hallmark Floors recommends pattern scribing with a utility knife or cutting with a power miter saw or vinyl guillotine cutter for cutting luxury vinyl tile.

10 GD. Center Point & Chalk Lines

Square tile cannot be installed using the same layout techniques as plank. Tile must begin from the center of the room. This will allow plenty of space to work outward to the walls to ensure a symmetrical pattern.

Establish the center point in the room by marking the center point of all four walls. Snap chalk lines between the center points of opposite walls. Make sure they're perfectly square and adjust as necessary.

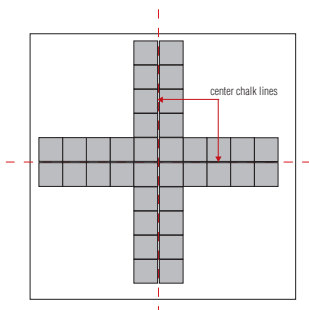

11 GD. Pattern Layout

Loose lay a row of tile along the center lines in both directions. If you have an unbalanced edge from one side to the other adjust your center line to maintain balance. Avoid having one edge with very thin tile and the other very wide. If using Polyurethane Grout, make sure you include spacers when planning the layout.

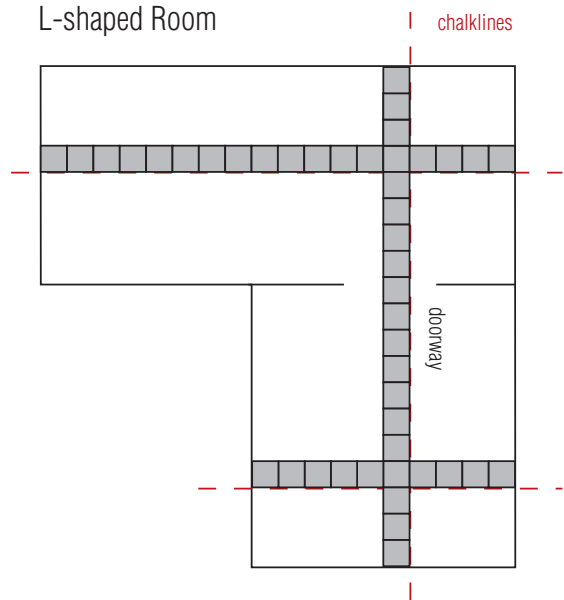

12 GD. Diagonal Pattern Layout

If installing tile on a 45° angle (diamond pattern), establish grid lines that allow the floor to be laid out in a balanced pattern.

NOTE: See Basic Pattern Section for more pattern options.

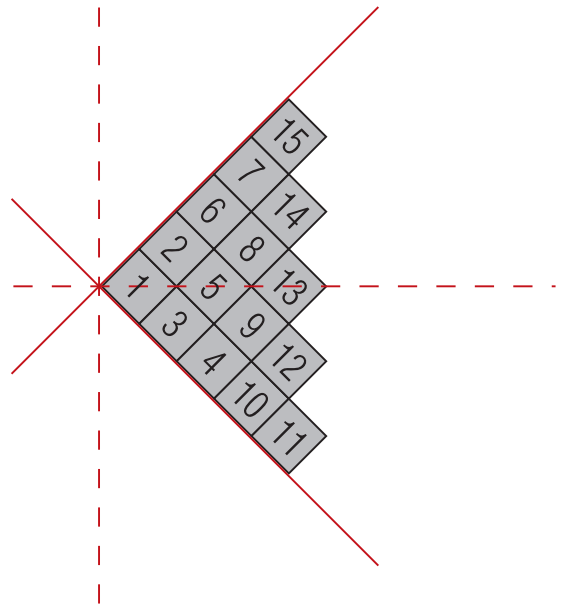

12 GD. Cutting Tiles

Tiles can be cut by pattern scribing with utility knife and snapping the tile, or by cutting with a vinyl guillotine cutter or table saw with a sharp, high tooth-count blade. (Tile is too wide to cut with chop saw).

13 GD. Set Tiles

Spread adhesive and set tile into the adhesive while avoiding any movement of the tile.

After installation has begun, begin laying Hallmark Floor luxury vinyl tiles along the starting lines and work out towards the surrounding walls.

Clean up all adhesive residue from surface of floor as you proceed. Do not allow adhesive to dry on the surface of the tiles.

14 GD. Roll Floor

After completion of the installation, the floor must be rolled with a minimum 100 lb. 3-section floor roller in both directions. Cover steel rollers with fresh duct tape before every use to prevent steel rollers damaging the surface of the floor.

15 GD. Install Trim/Moldings

Cover all exposed areas. Use appropriate trim pieces along all walls, cabinets, etc. Use appropriate transition pieces in doorways or where Hallmark Floors luxury vinyl meets other flooring.

16 GD. Clean Up

Remove all glue residue from the floor and vacuum up remaining debris.

Other than glue residue removal and vacuuming, do not clean the floor for 48 hours after installation. After 48 hours, use a damp mop with well-wrung-out sponge mop to remove residue and clean with Hallmark Trueclean.

ATTENTION!: Exposure to direct sunlight and other heat sources may affect the performance of the floor. Temporary paper shades/sheets over windows/glass doors can protect the floor surface from excessive heat and light. This will provide a measure of protection until permanent window coverings can be installed.

18" x 18" and 18" x 36" Basic Patterns

Tile

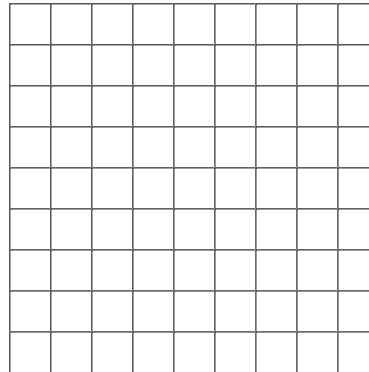

Checker Board

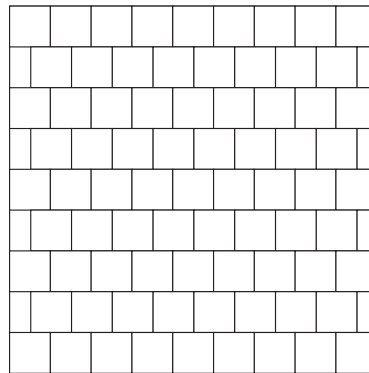

Brick

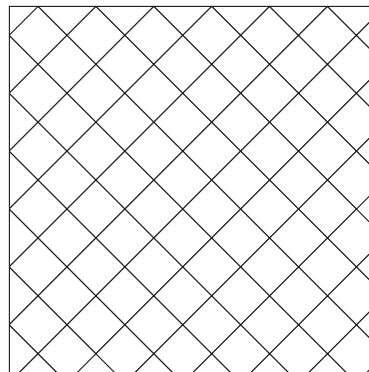

Checker Board 45°

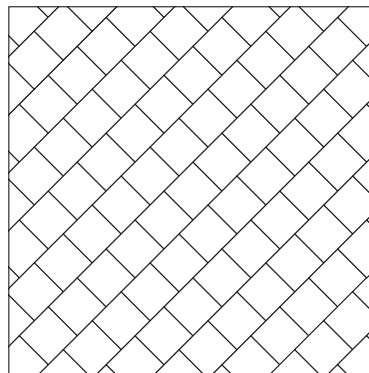

Brick 45°

Glue Down Installation 18" x 18" or 18" x 36" Vinyl Tile

3MM: 18"x36" tile

Note: Proper layout is critical to the performance and appearance of the product.

Before installing any material, plan the layout of the tile end joints to avoid lining up on top of the sub floor/underlayment joints. Do not install tile joints over expansion joints.

Installation Tools GLUE DOWN TILE

Tape measure, pencil, chalk line, table saw, vinyl guillotine, jamb saw, spacers, hammer, safety glasses, hearing protection, utility knife, specified notched trowel, wall spacers, straight edge, broom, speedy square, luxury vinyl floor cleaner, and shop vacuum.

NOTE: Hallmark Floors recommends pattern scribing, with utility knife or cutting with a power miter saw or vinyl guillotine cutter for cutting luxury vinyl tile

10 GDT. Center Point & Chalk Lines

Rectangular tile cannot be installed using the same layout techniques as plank. Tile must begin from the center of the room. This will allow plenty of space to work outward to the walls to ensure a symmetrical pattern.

Establish the center point in the room by marking the center point of all four walls. Snap chalk lines between the center points of opposite walls. Make sure they're perfectly square and adjust as necessary.

11 GDT. Pattern Layout

Loose lay a row of tile along the center lines in both directions. If you have an unbalanced edge from one side to the other adjust you center line to maintain balance. Avoid having one edge with very thin tile and the other very wide. If using polyurethane grout make sure you include spacers when planning the layout. Rectangular tile has many options for installation layout. Ensure you are familiar/experienced with these types of installation as chalk layout lines will have to be used to ensure the pattern does not drift. 18" x 36" tiles are large format, and some patterns may not be suitable for smaller rooms. Dry lay a small portion of the pattern or graph out room size on paper.

The starting point in a modular installation must be as close to the center of the room as possible and must be positioned to center the pattern in the room. Snap a chalk line parallel to one major wall bisecting the starting point. It may be necessary to offset the center chalk line to assure perimeter modules will be at least half size.

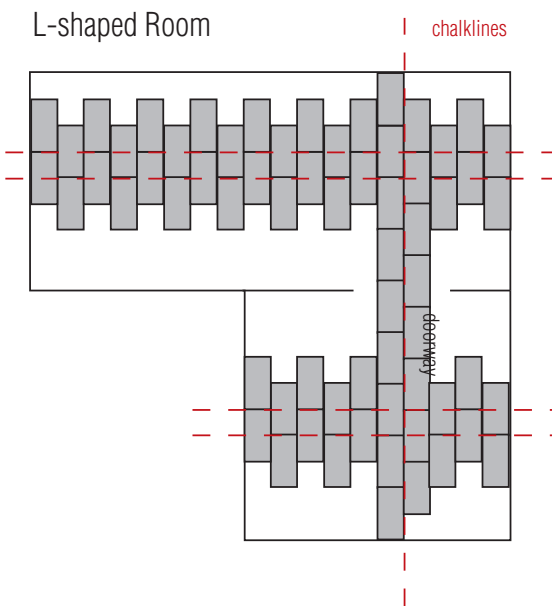
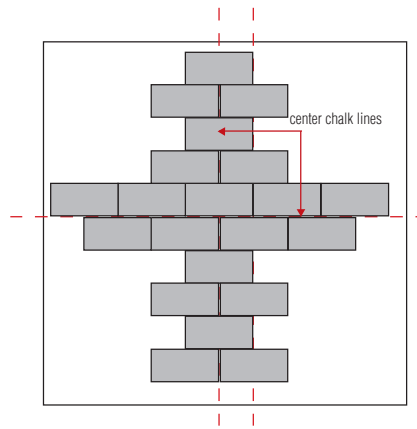

12 GDT. Diagonal Patterns

If installing tile on a 45° angle, establish grid lines that allow the floor to be laid out in a balanced pattern.

NOTE: See Basic Pattern Section for more pattern options.

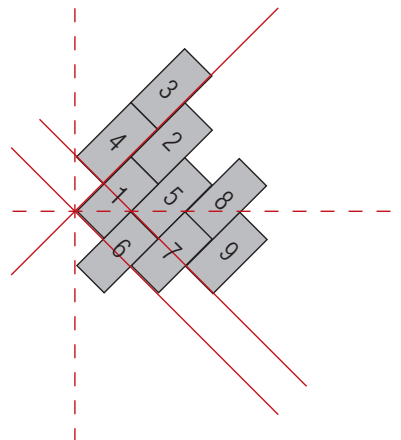

12 GDT. Cutting Tiles

Tiles can be cut by pattern scribing with utility knife and snapping the tile, or by cutting with a vinyl guillotine cutter or table saw with a sharp, high tooth-count blade. (Tile is too wide to cut with chop saw).

13 GDT. Set Tiles

Spread adhesive and set tile into the adhesive while avoiding any movement of the tile.

After installation has begun, begin laying Hallmark Floor luxury vinyl tiles along the starting lines and work out towards the surrounding walls.

Clean up all adhesive residue from surface of floor as you proceed. Do not allow adhesive to dry on the surface of the tiles.

14 GDT. Roll Floor

After completion of the installation, the floor must be rolled with a minimum

100 lb. 3-section floor roller in both directions. Cover steel rollers with fresh duct tape before every use to prevent steel rollers damaging the surface of the floor.

15 GDT. Install Trim/Moldings

Cover all exposed areas. Use appropriate trim pieces along all walls, cabinets, etc. Use appropriate transition pieces in doorways or where Hallmark Floors luxury vinyl meets other flooring.

16 GDT. Clean Up

Do not clean the floor for 48 hours after installation.

After 48 hours, use a damp mop with well-wrung-out sponge mop to remove residue and clean with Hallmark Trueclean.

ATTENTION!: Exposure to direct sunlight and other heat sources may affect the performance of the floor. Temporary paper shades/sheets over windows/glass doors can protect the floor surface from excessive heat and light. This will provide a measure of protection until permanent window coverings can be installed.

18" x 36" Basic Patterns

Rectangular Tile

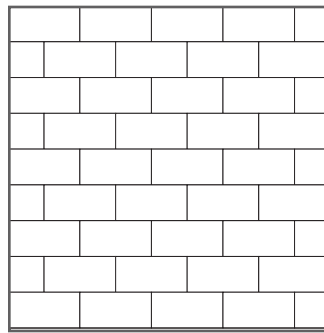

Brick

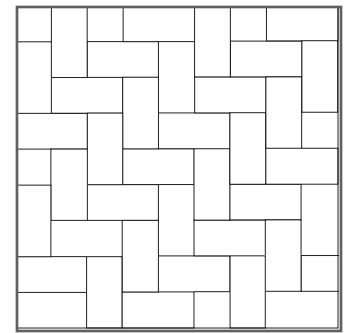

Herringbone 90°

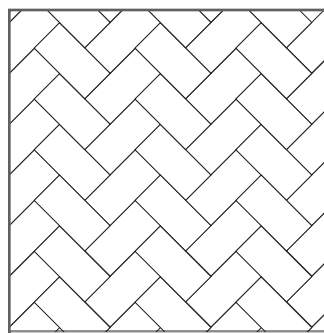

Herringbone 45°

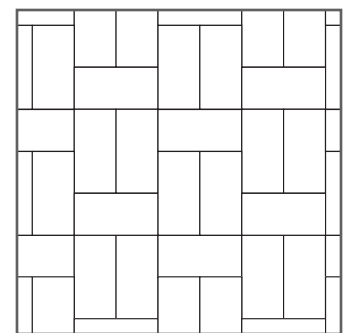

Single Basket Weave

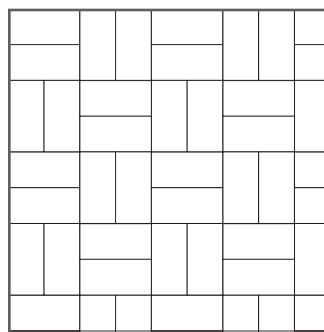

Double Basket Weave

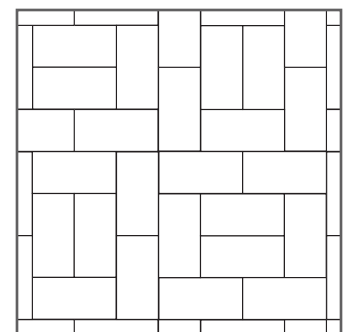

Wrapped Basket Weave

18" x 36" Pattern Setup

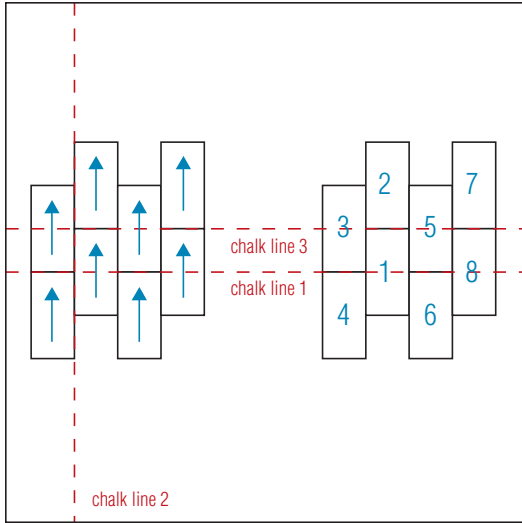

Brick

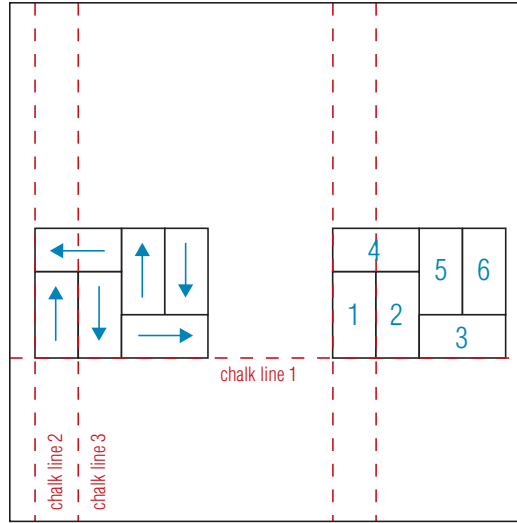

Single Basket Weave

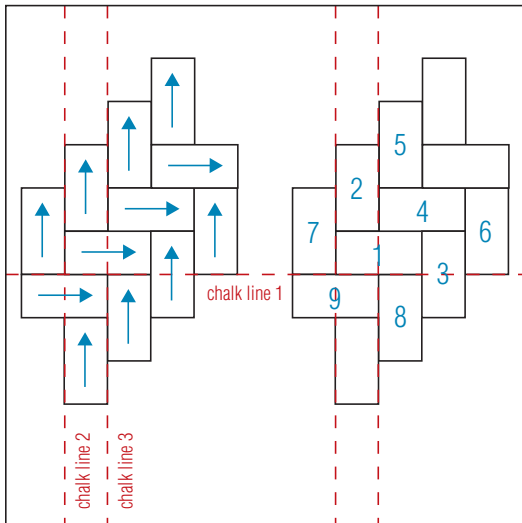

Herringbone 90°

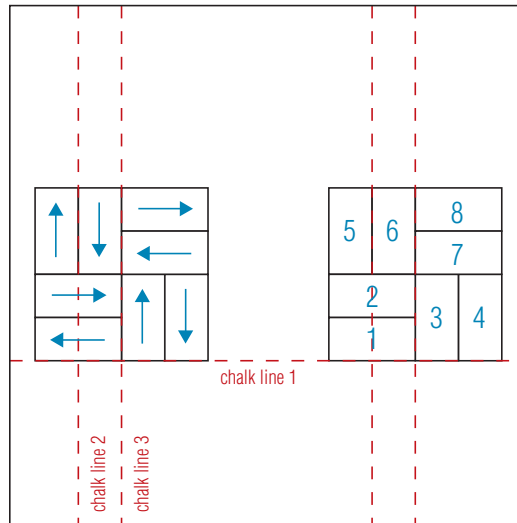

Double Basket Weave

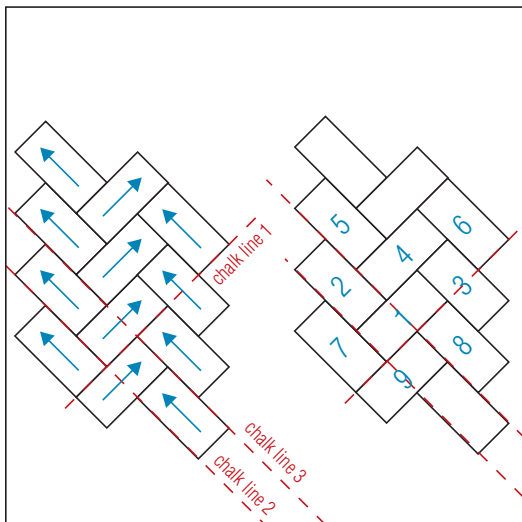

Herringbone 45°

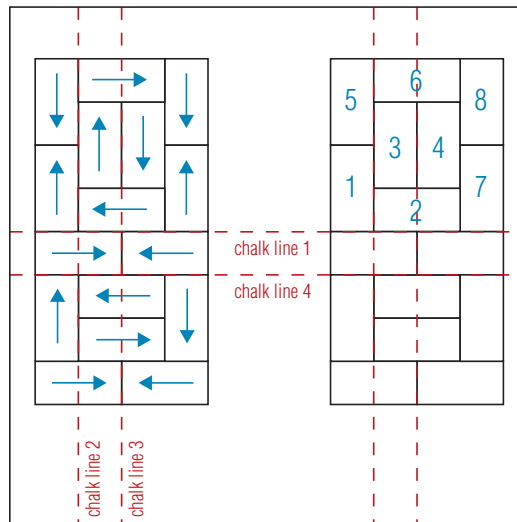

Wrapped Basket Weave



2360 S. Archibald Ave.
Ontario, CA 91761

p 888.551.0888

p 909.947.7736

f 909.947.7776

www.hallmarkfloors.com